

# SOMA-Würfel

## Einführung

Der SOMA-Würfel besteht aus sieben Somasteinen:

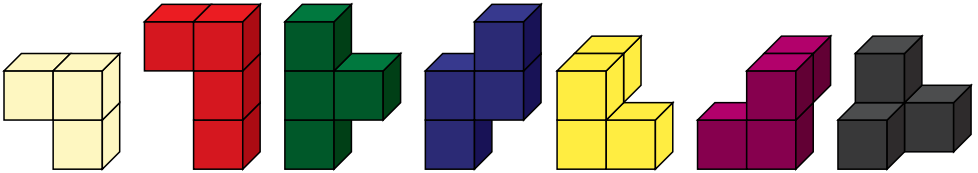

Das Grundproblem des SOMA-Würfels ist es, aus den sieben Einzelteilen einen Würfel zusammenzusetzen:

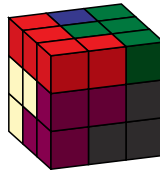

Es gibt 240 Lösungen für dieses Problem. Eine dieser Lösungen ist auf der Karte 23 abgebildet.

Aus den SOMA-Würfelteilen kann man aber auch viele andere Figuren bauen:

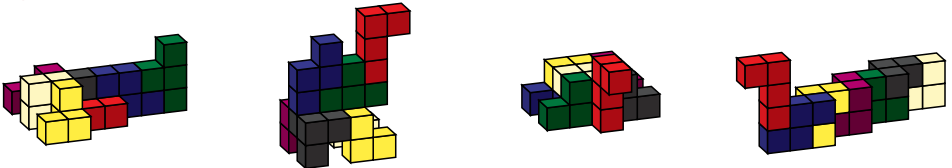

### Hinweis

Bei den Aufgabenkarten sind auf der Rückseite die Lösungen abgedruckt. Versuche aber zuerst die Aufgabe alleine zu lösen.



# Somafiguren

Aufgabe: Baue das Kanu aus zwei Somateilen.

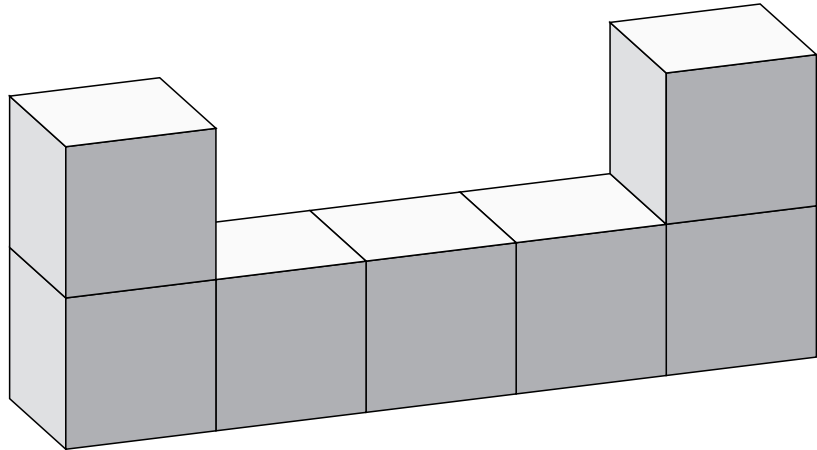

Kanu



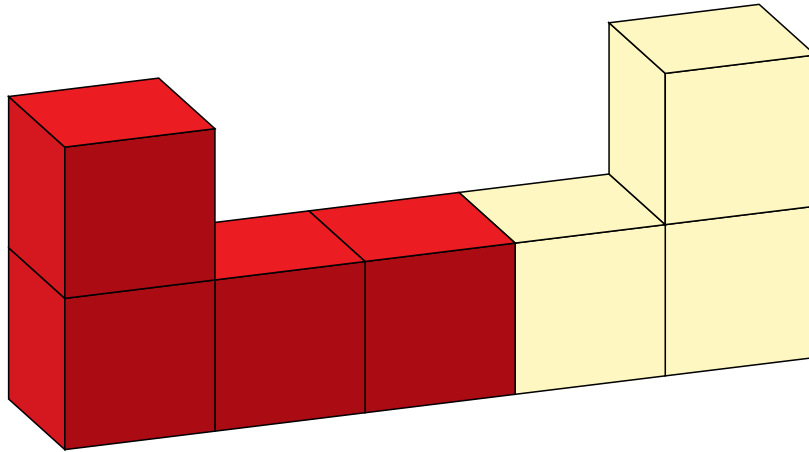



# Somafiguren

Aufgabe: Baue den Hund aus zwei Somateilen.

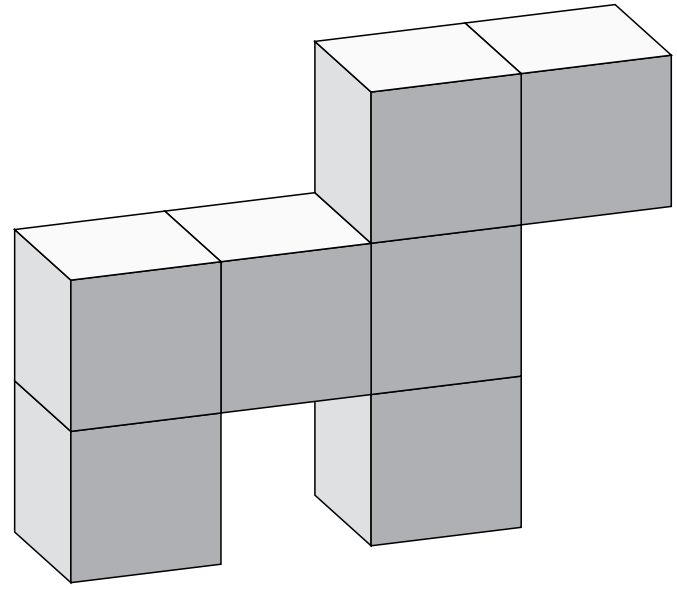

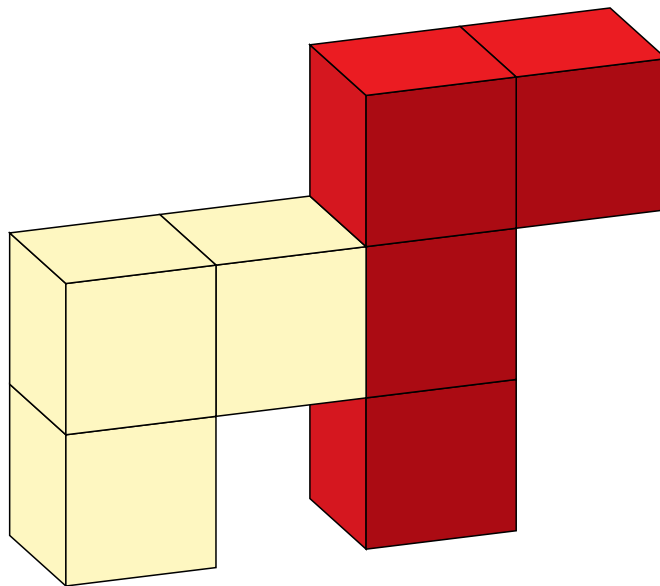

# Somafiguren

Aufgabe: Baue das Mauselloch aus zwei Somateilen.

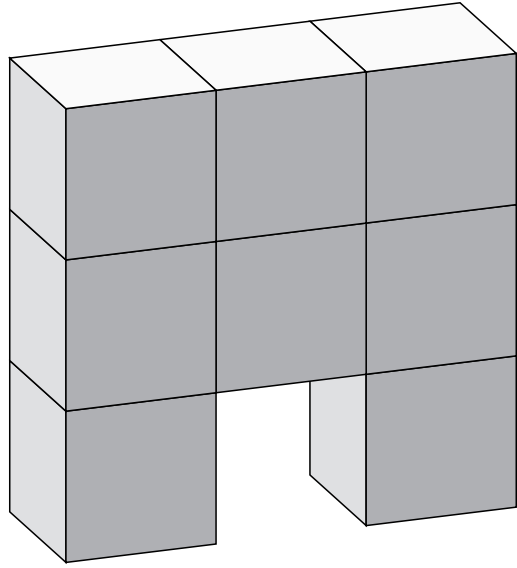

Mauselloch



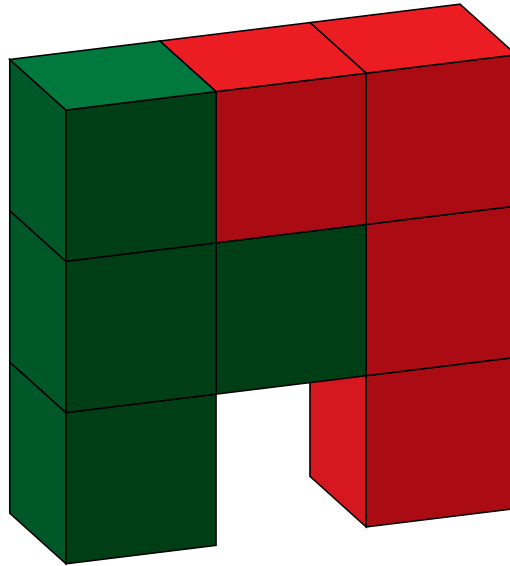



# Somafiguren

Aufgabe: Baue den Stuhl aus zwei Somateilen.

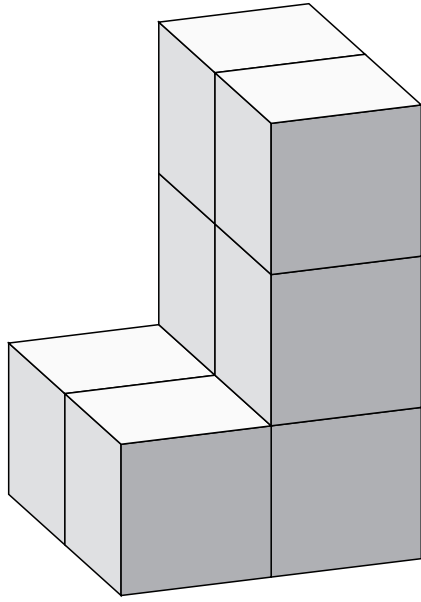

Stuhl





# Eine mögliche Lösung

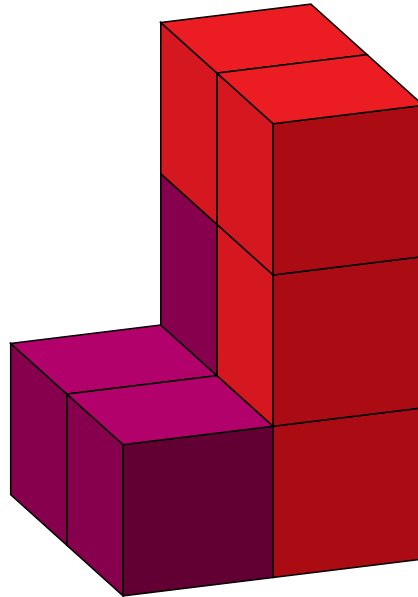



# Somafiguren

Aufgabe: Baue den Topfdeckel aus drei Somateilen.

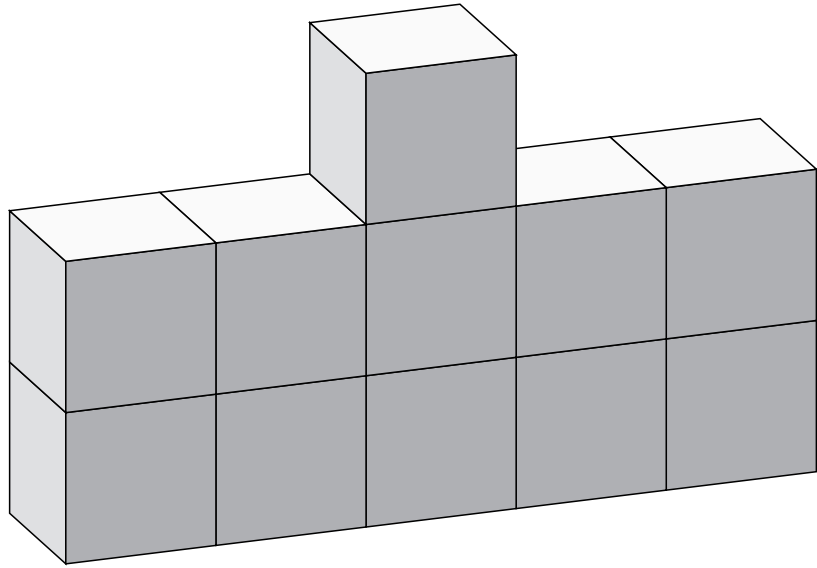

Topfdeckel



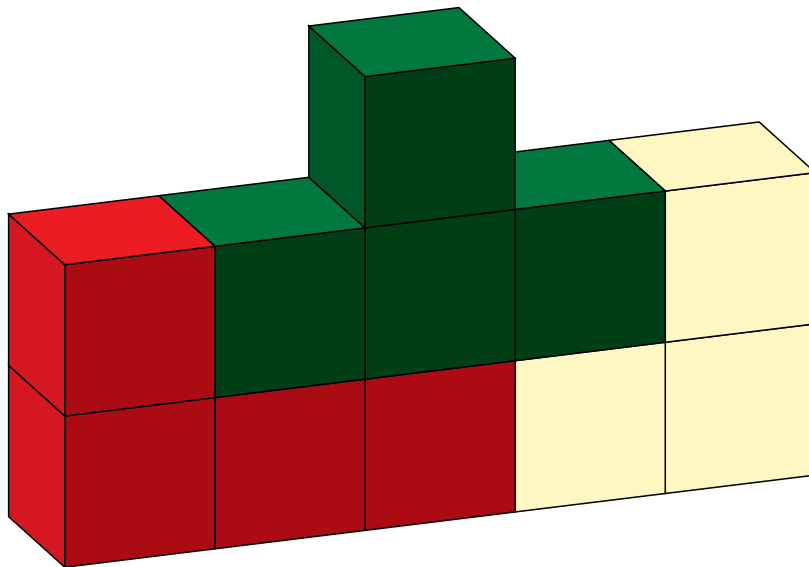



# Somafiguren

Aufgabe: Baue das Schlüsselloch aus drei Somateilen.

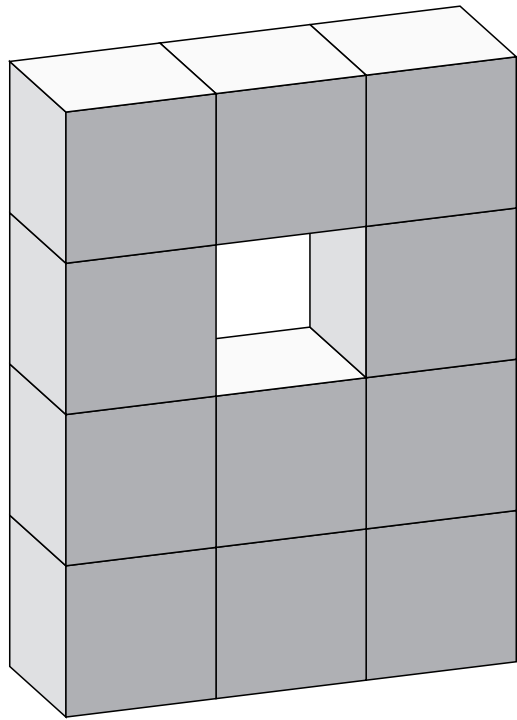

Schlüsselloch



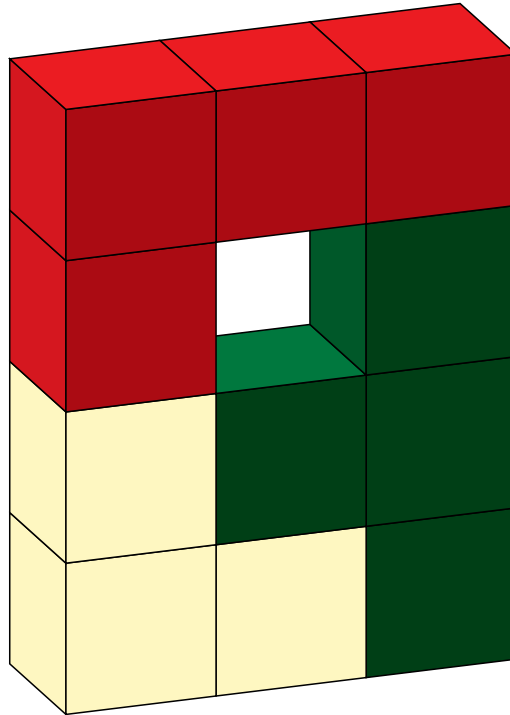



# Somafiguren

Aufgabe: Baue die Box aus drei Somateilen.

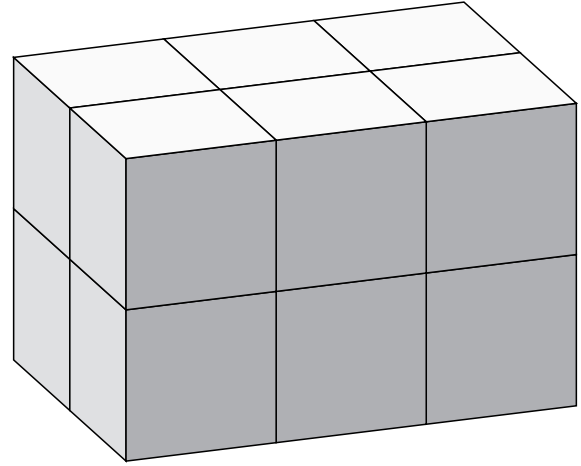

# Eine mögliche Lösung

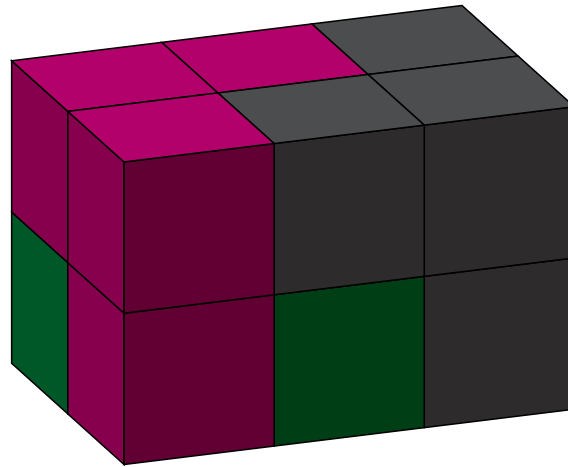



# Somafiguren

Aufgabe: Baue die Parkbank aus drei Somateilen.

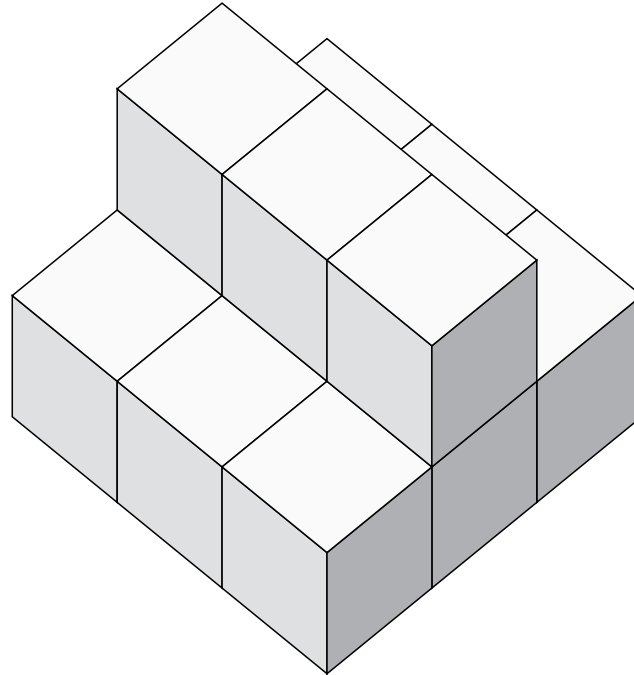



# Eine mögliche Lösung

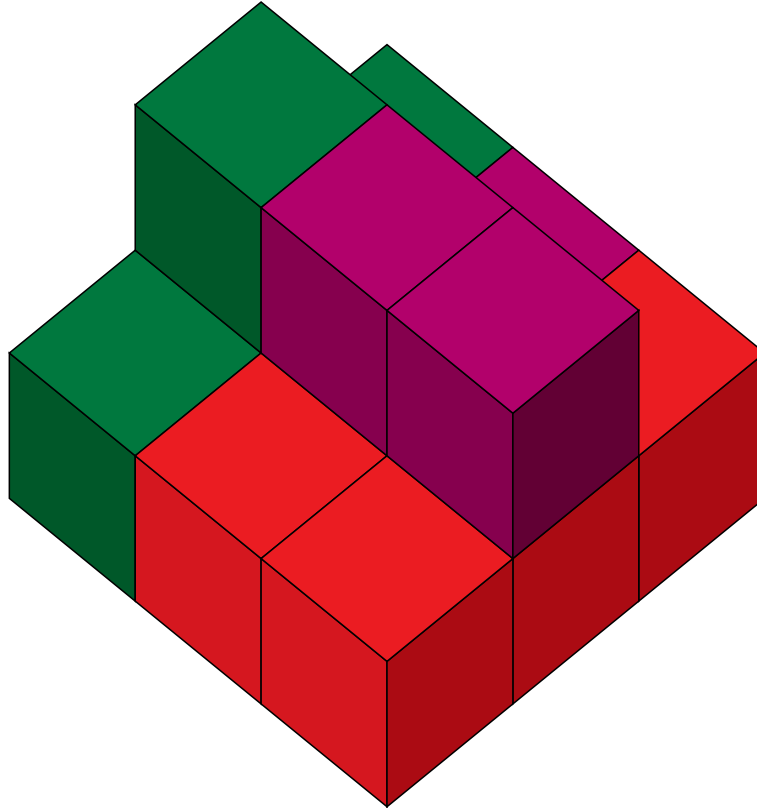



# Somafiguren

Aufgabe: Baue die Treppe aus vier Somateilen.

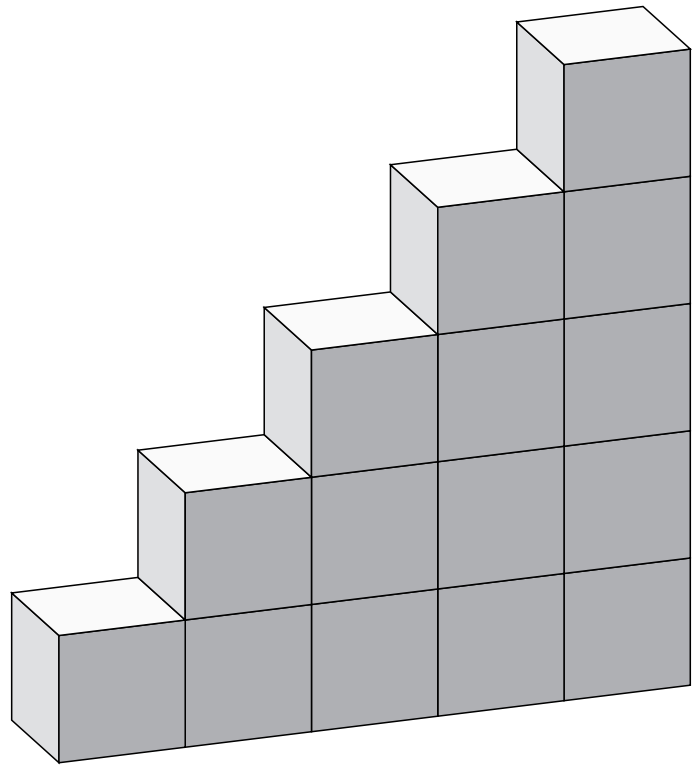

Stufen



# Eine mögliche Lösung

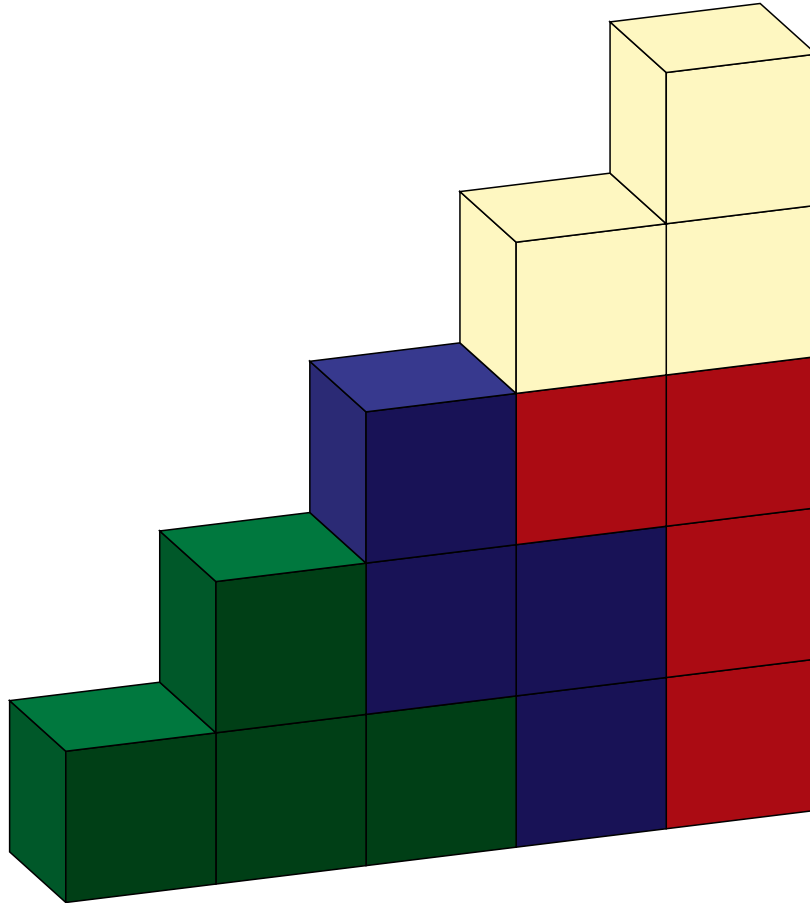



# Somafiguren

Aufgabe: Baue die Ecke aus vier Somateilen.

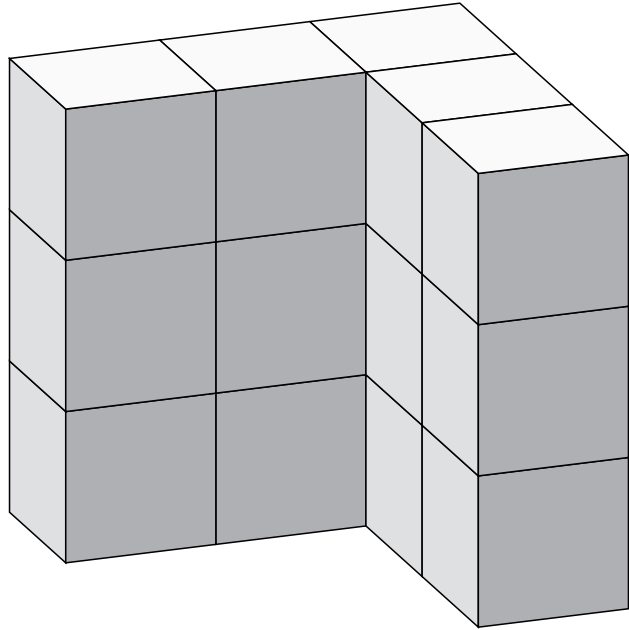

Ecke



# Eine mögliche Lösung

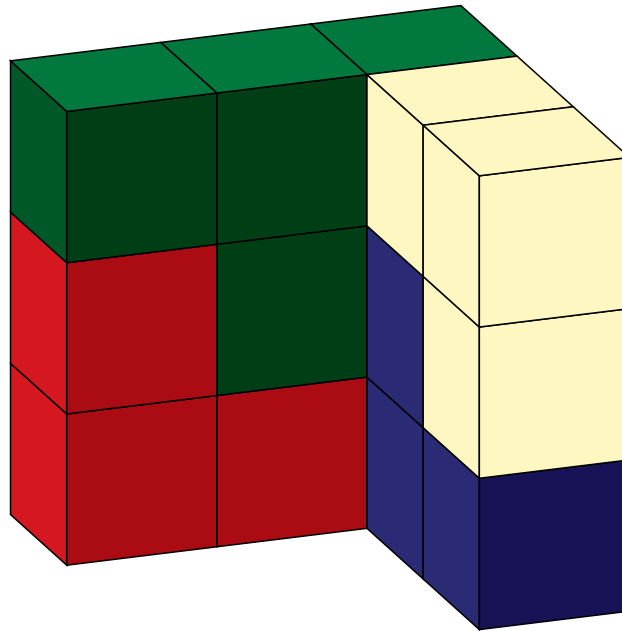



# Somafiguren

Aufgabe: Baue das Bett aus vier Somateilen.

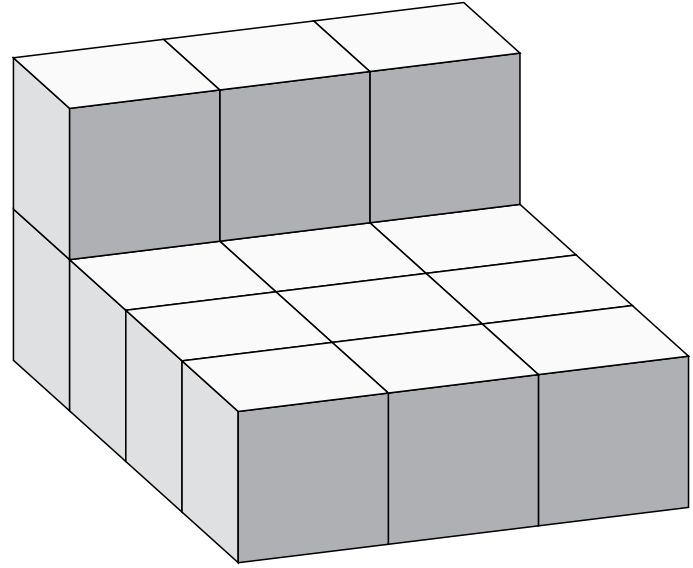

Bett



# Eine mögliche Lösung

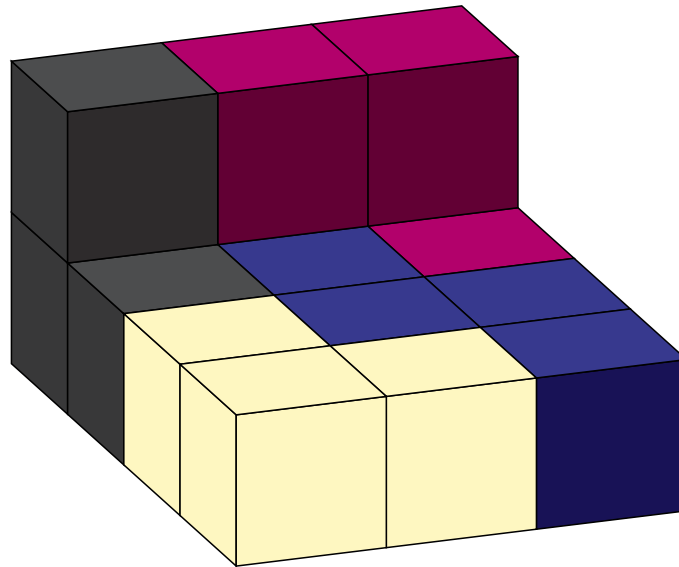



# Somafiguren

Aufgabe: Baue die Wand aus vier Somateilen.

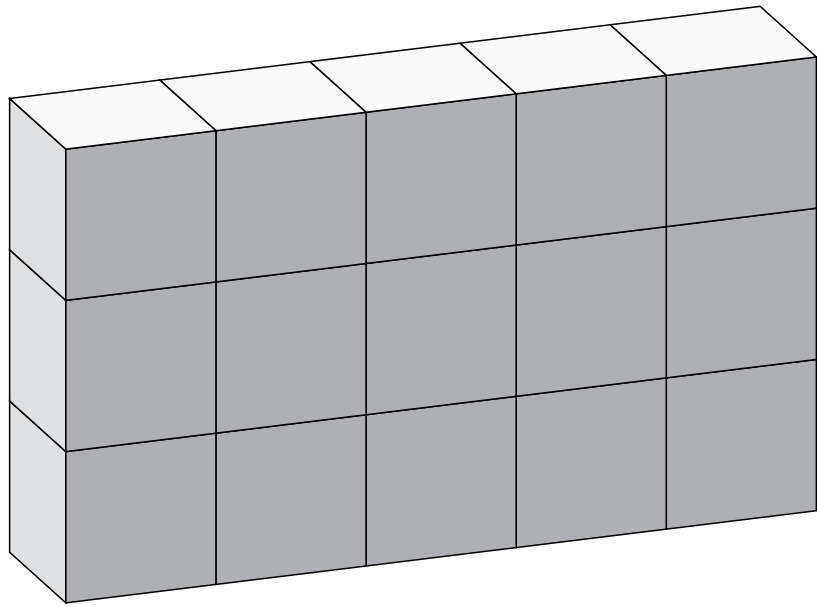

Wand





# Eine mögliche Lösung

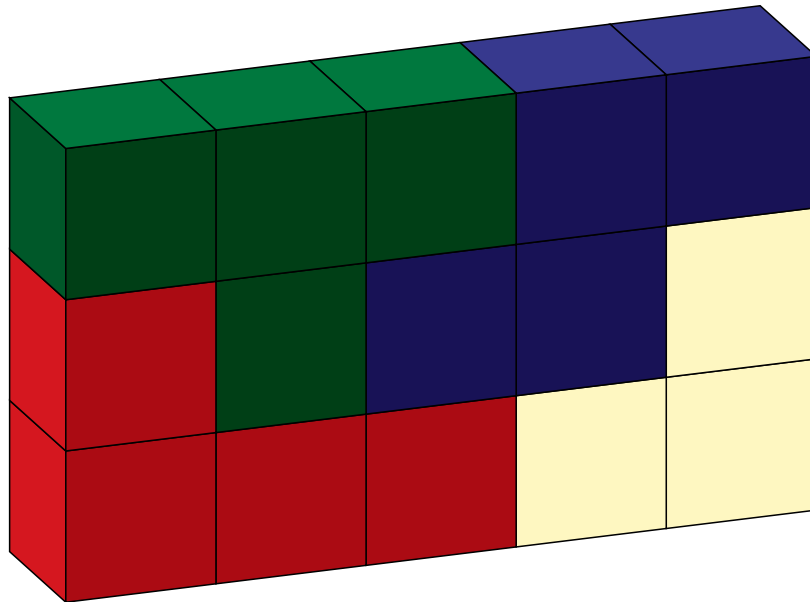

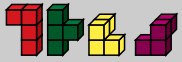

# Somafiguren

Aufgabe: Baue den Buchstaben H aus vier Somateilen.

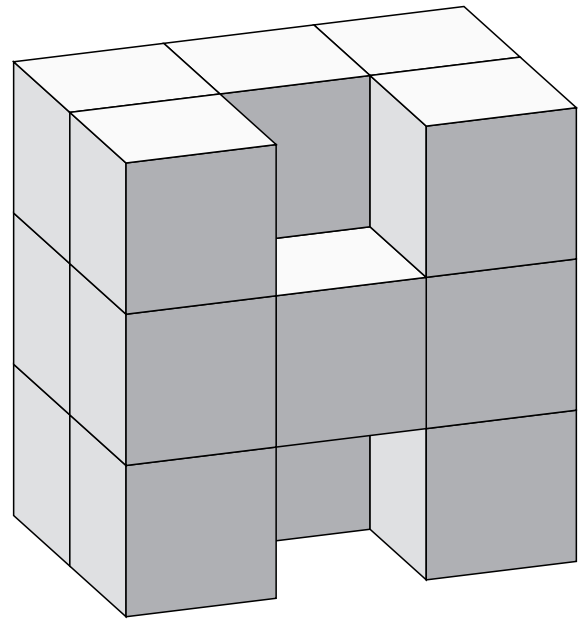

## Eine mögliche Lösung

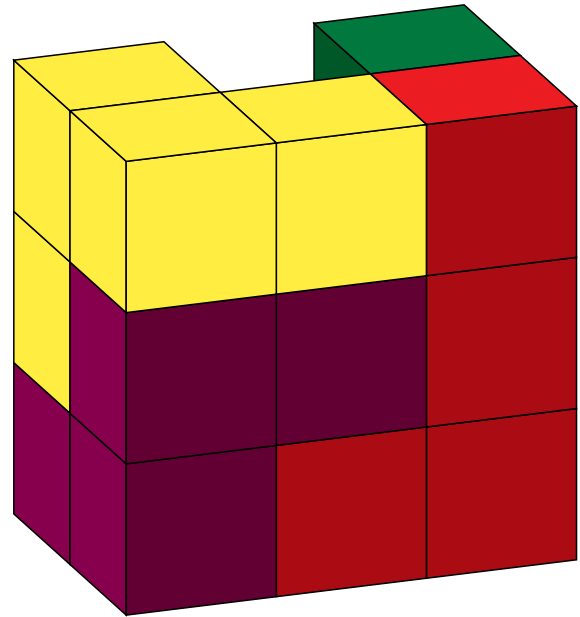
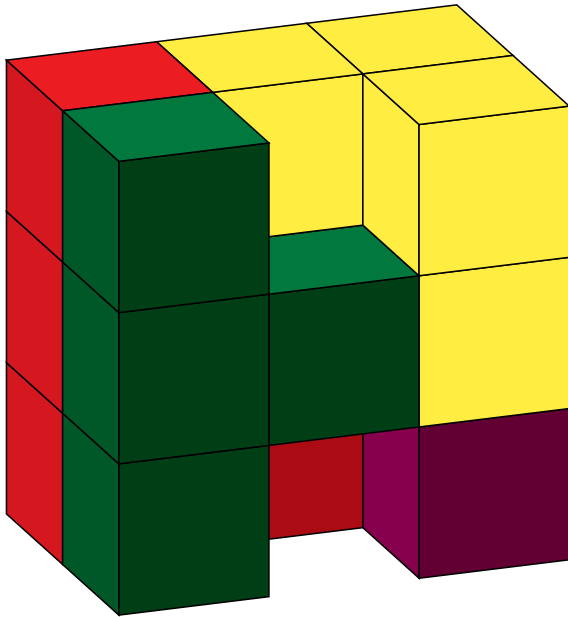



# Somafiguren

Aufgabe: Baue die Kellertreppe aus vier Somateilen.

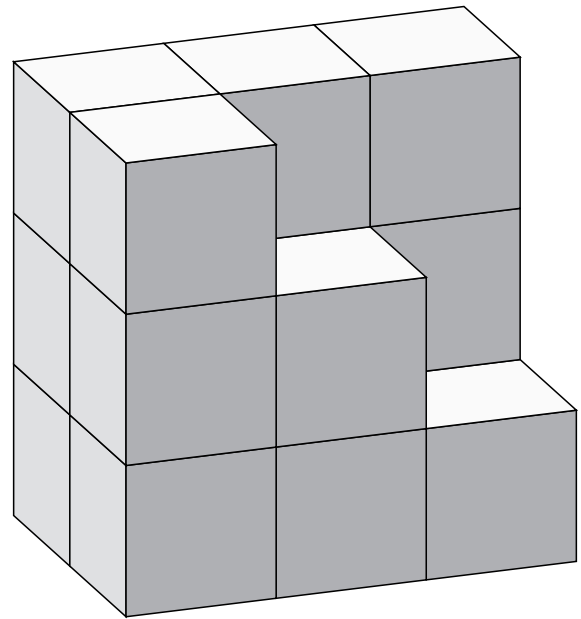

Kellertreppe



## Eine mögliche Lösung

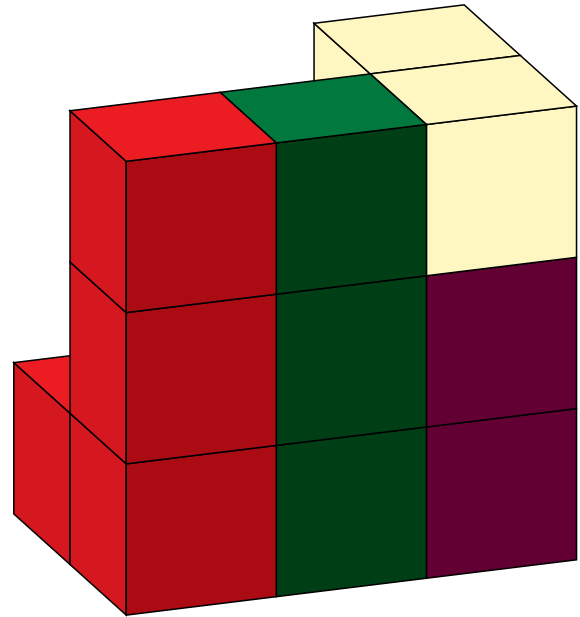
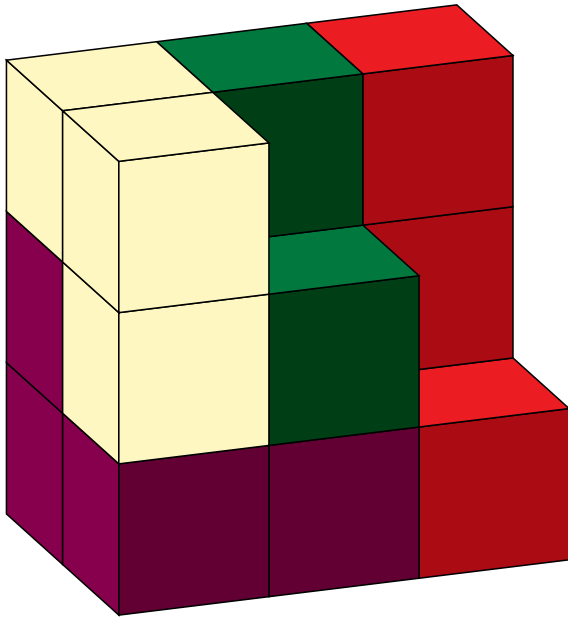

# Somafiguren

15

Aufgabe: Baue den Schwan aus allen sieben Somateilen.

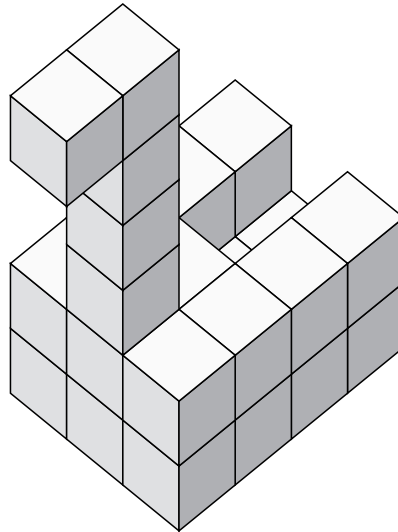

Schwan



# Eine mögliche Lösung

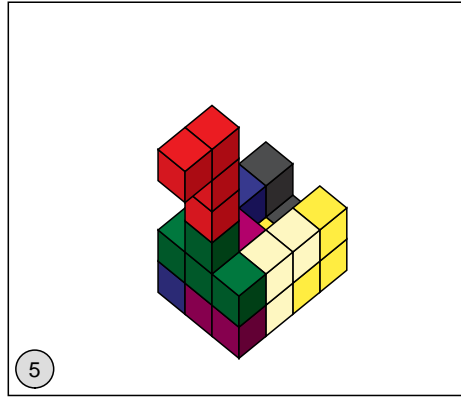
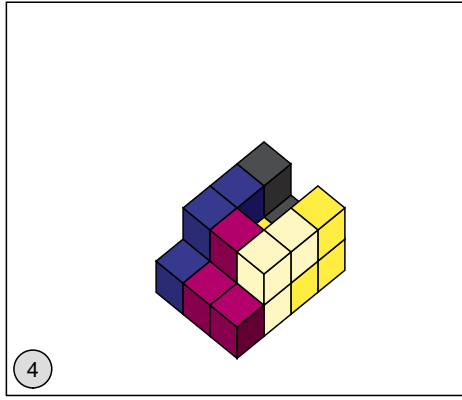
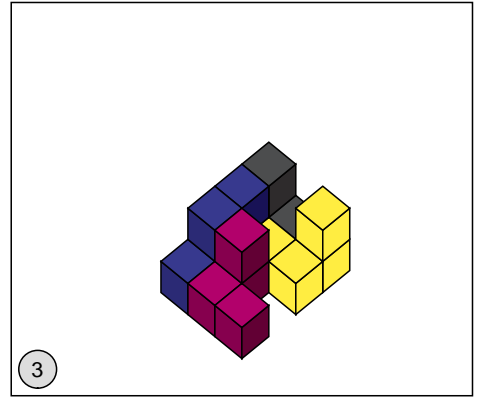
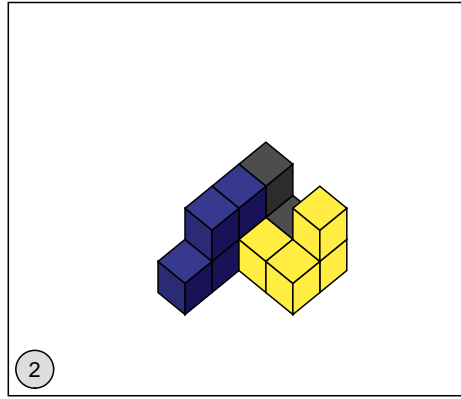
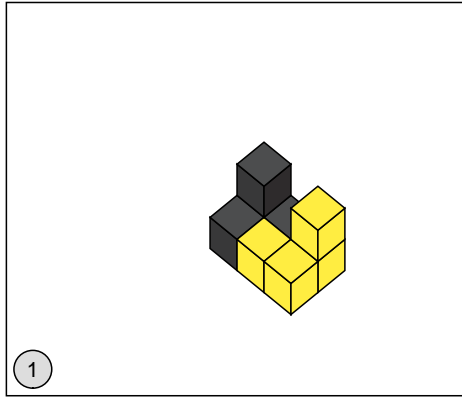

# Somafiguren

16

Aufgabe: Baue die Ente aus allen sieben Somateilen.

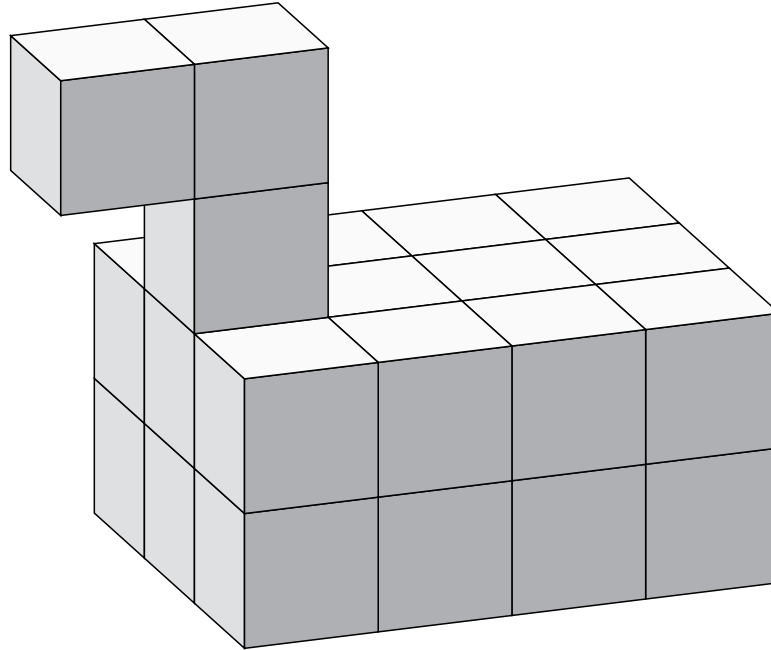

Ente





## Eine mögliche Lösung

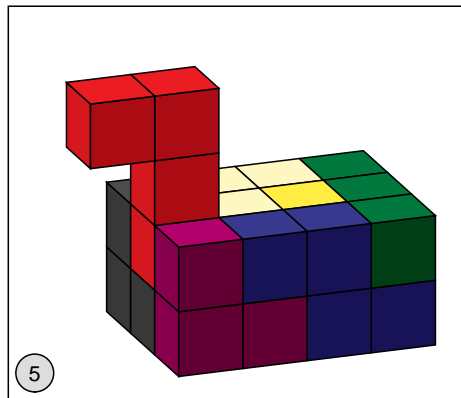
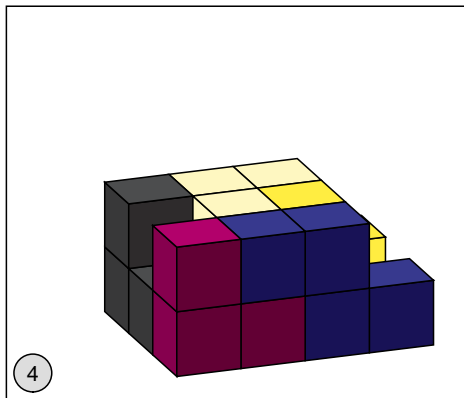
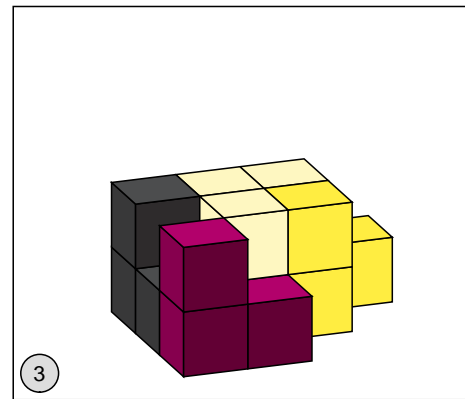
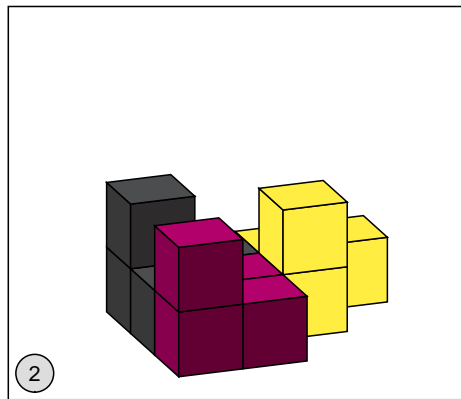
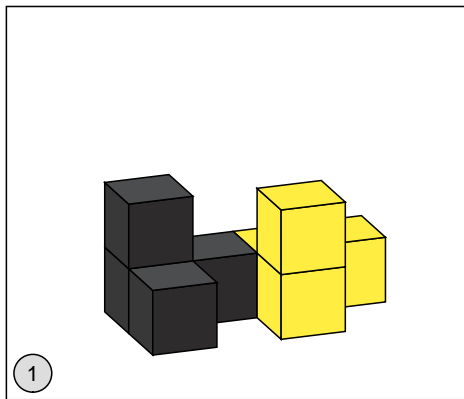

# Somafiguren

17

Aufgabe: Baue den Thron aus allen sieben Somateilen.

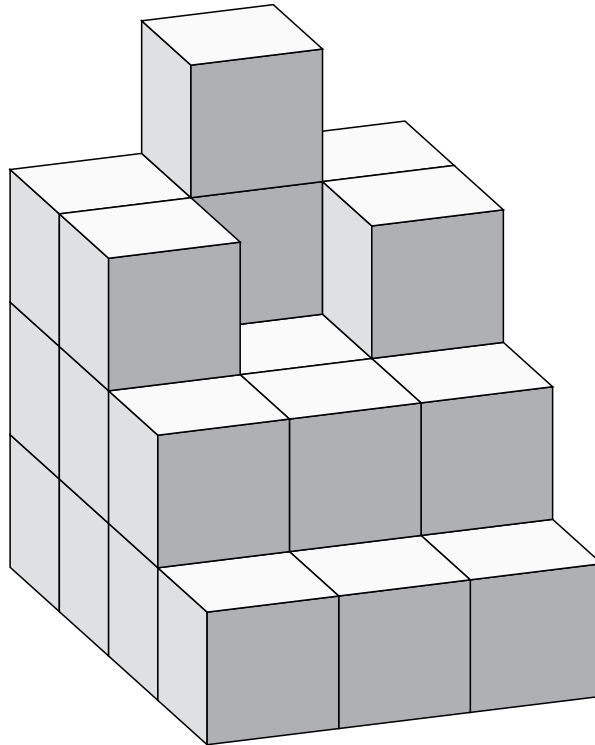

Thron



## Eine mögliche Lösung

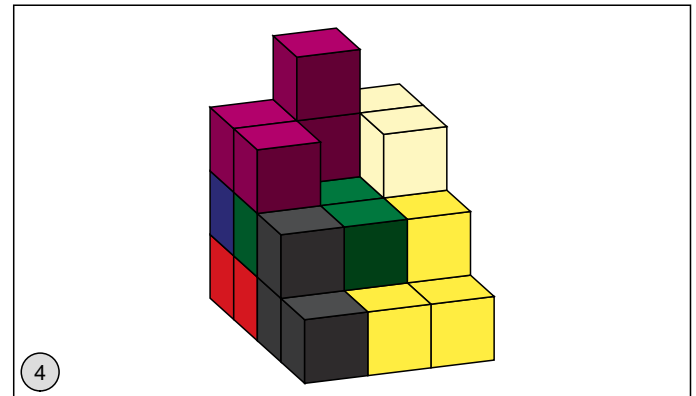
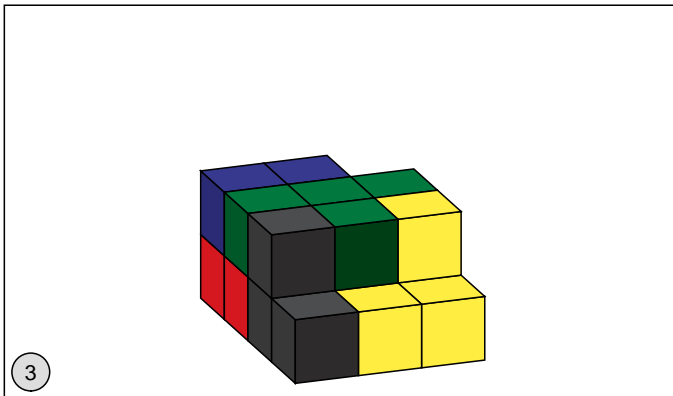
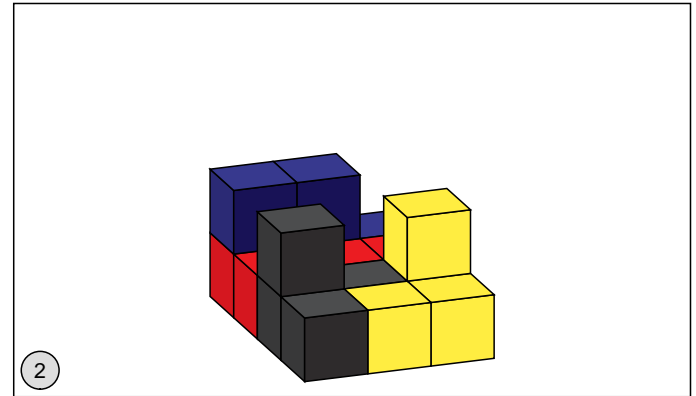
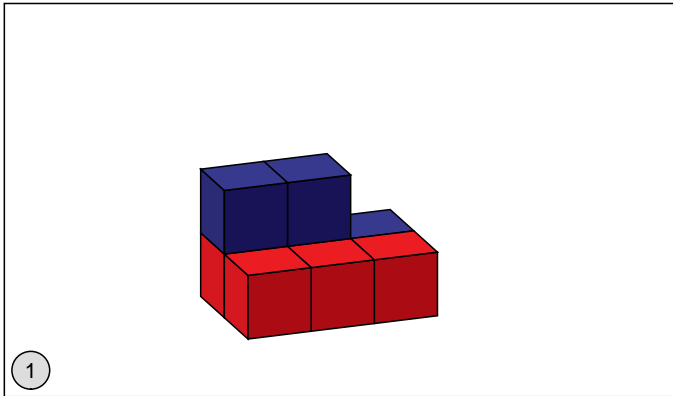

# Somafiguren

18

Aufgabe: Baue das kleine Bett aus allen sieben Somateilen.

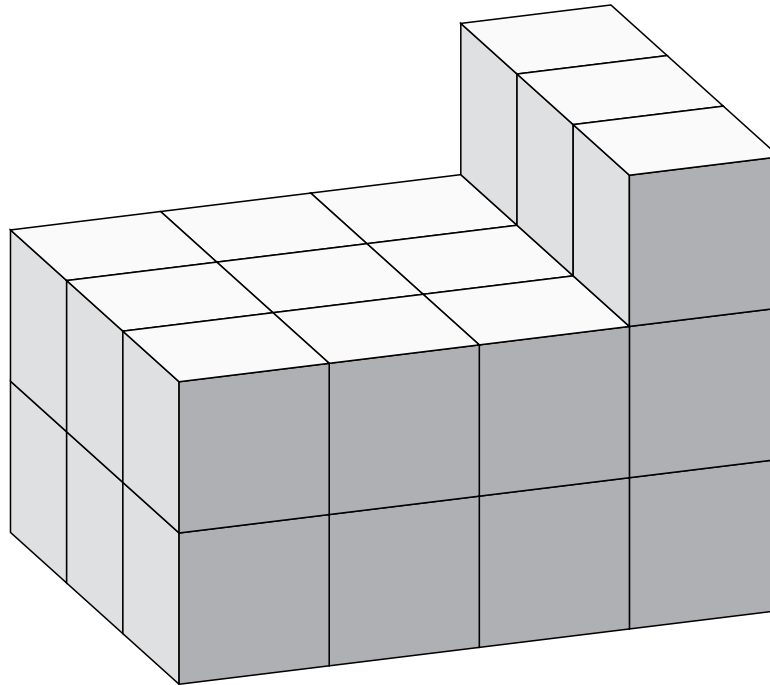

Kleines Bett



## Eine mögliche Lösung

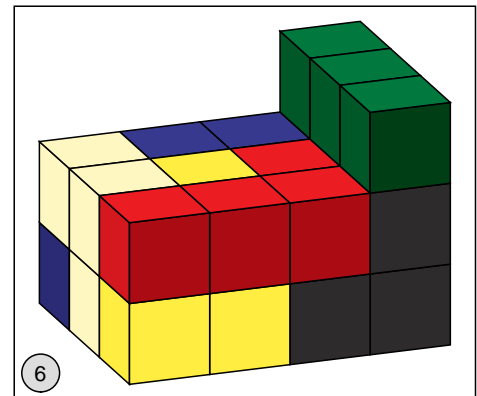
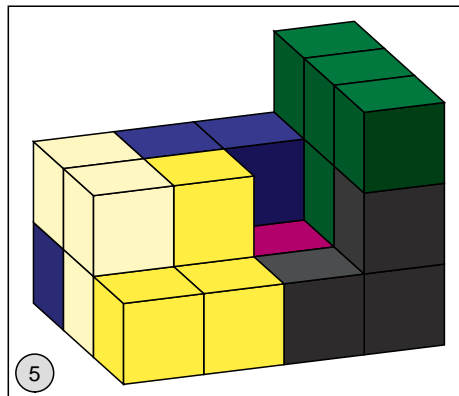
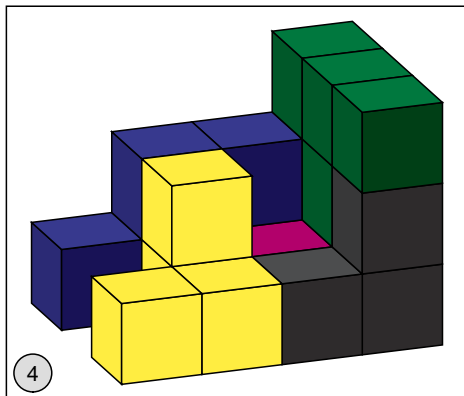
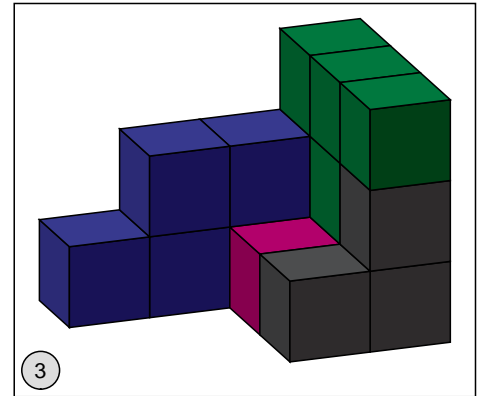
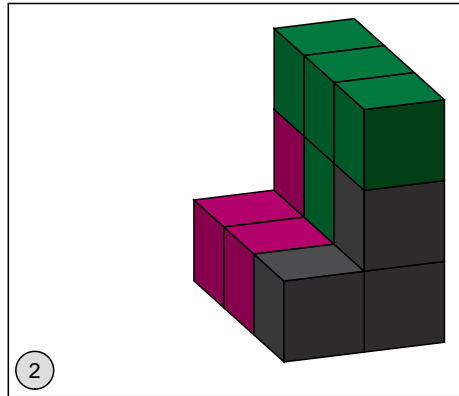
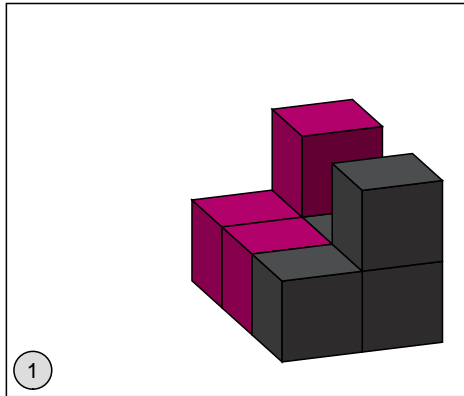

# Somafiguren

19

Aufgabe: Baue die Treppe aus allen sieben Somateilen.

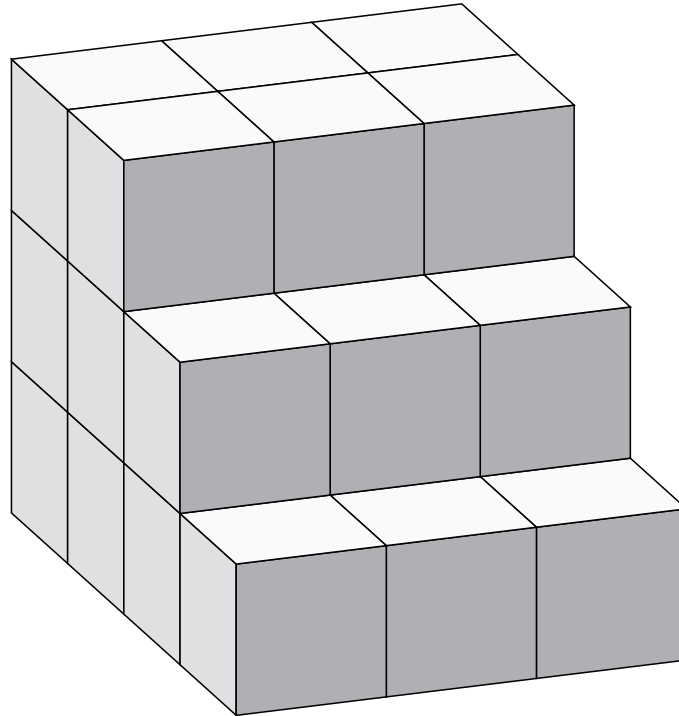

Treppe



## Eine mögliche Lösung

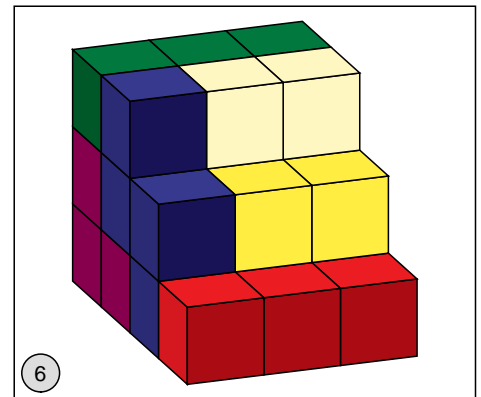
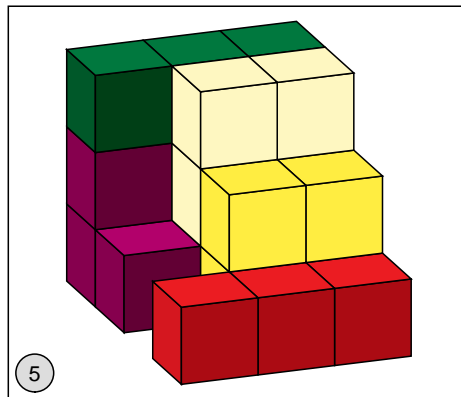
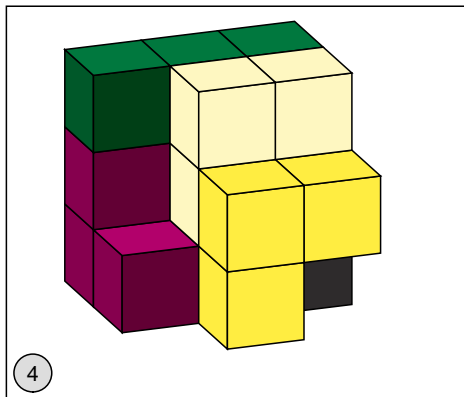
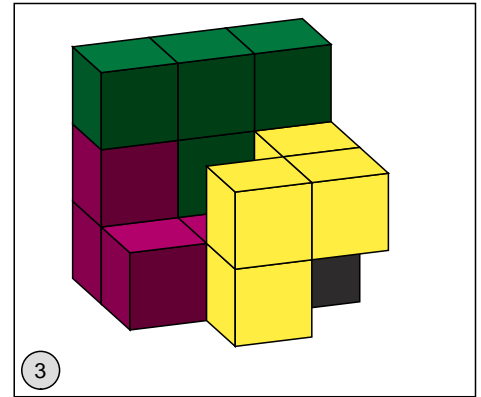
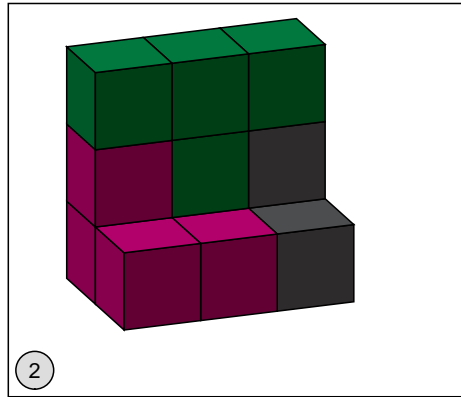
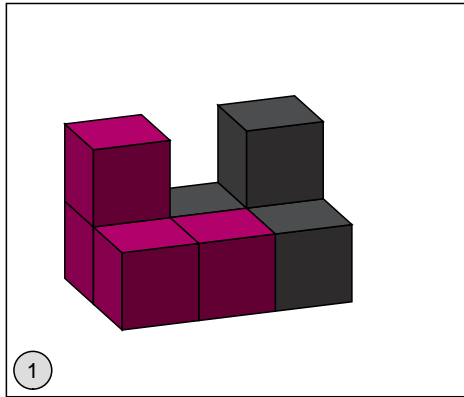

# Somafiguren

20

Aufgabe: Baue die Schnecke aus allen sieben Somateilen.

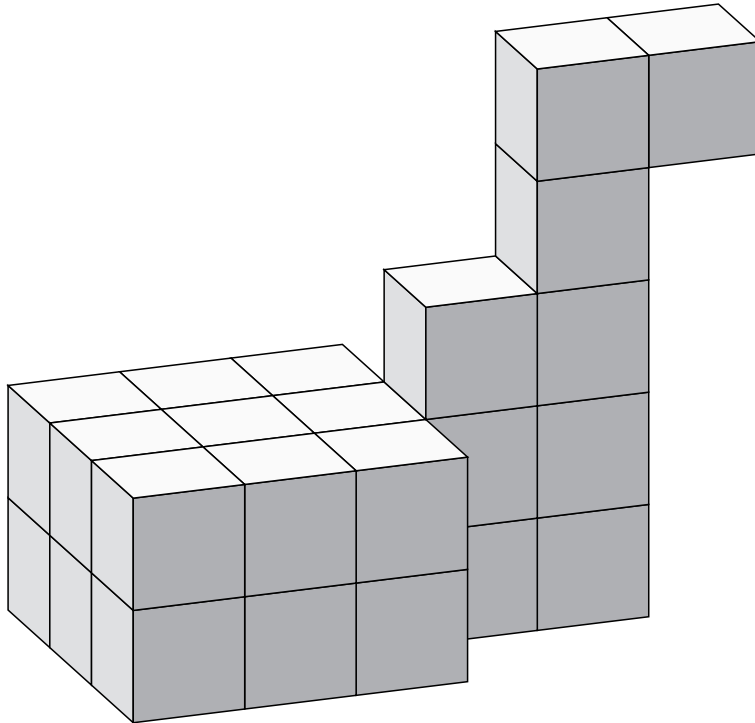

Schnecke





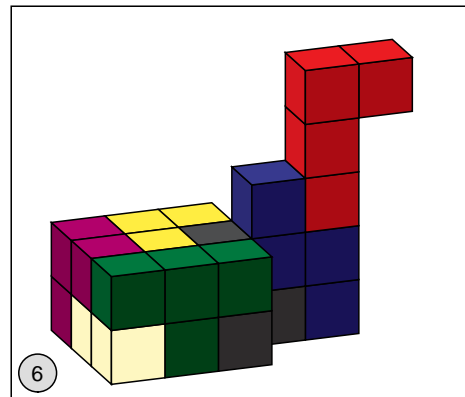
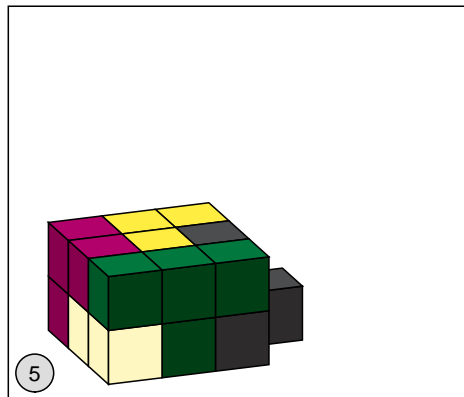
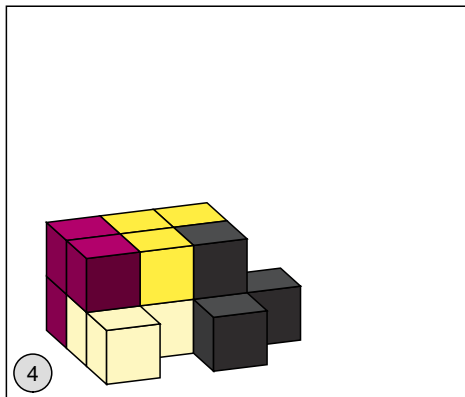
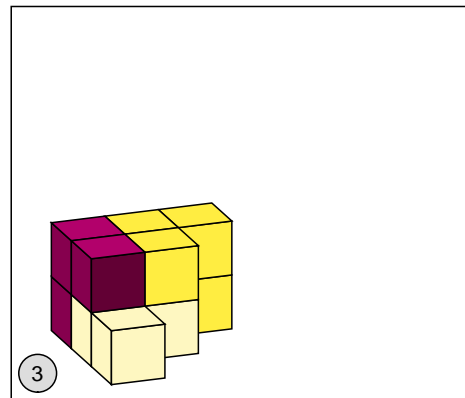
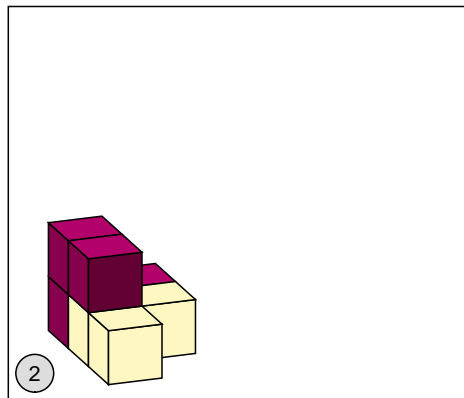
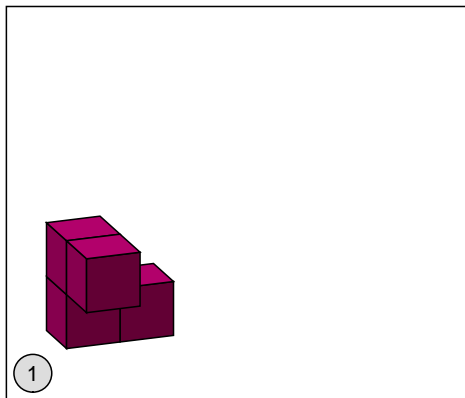

# Somafiguren

21

Aufgabe: Baue die Wanne aus allen sieben Somateilen.

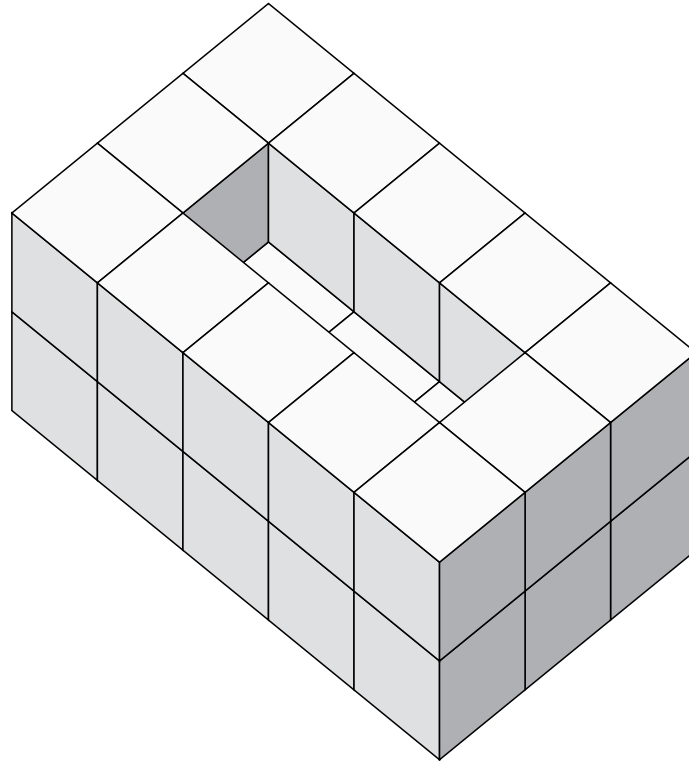

Wanne



# Eine mögliche Lösung

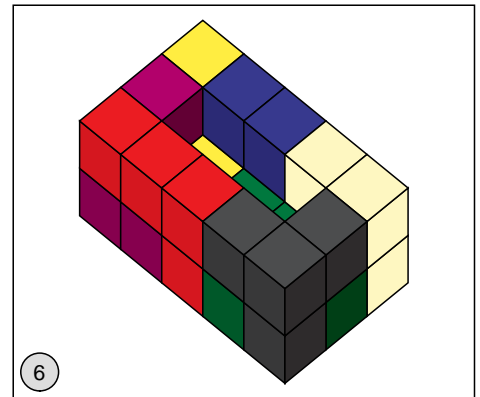
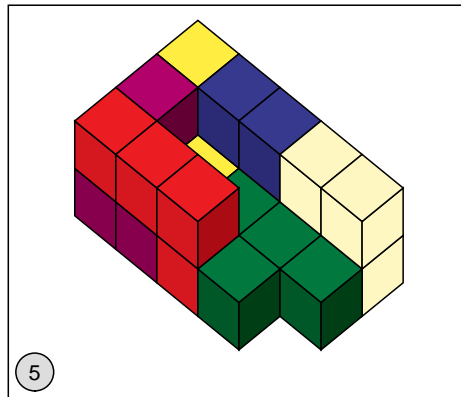
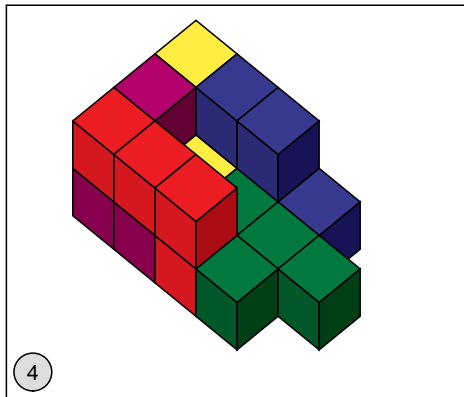
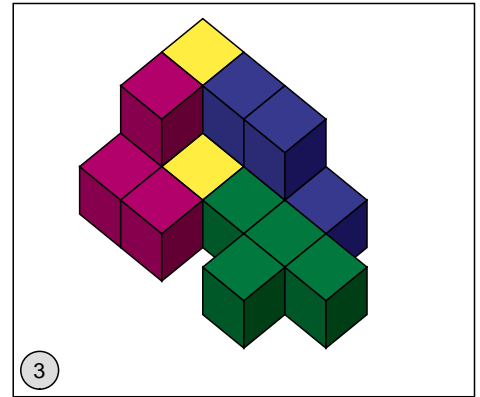
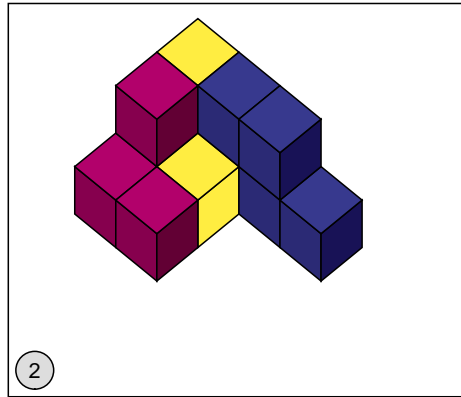
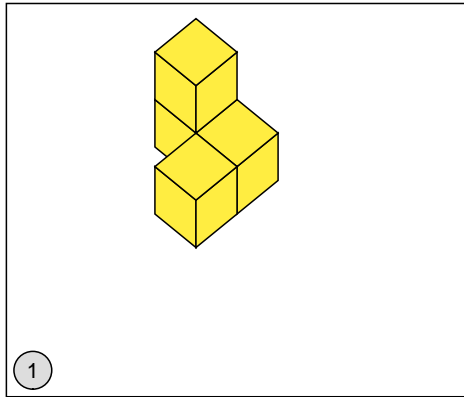

# Somafiguren

22

Aufgabe: Baue den Stuhl aus allen sieben Somateilen.

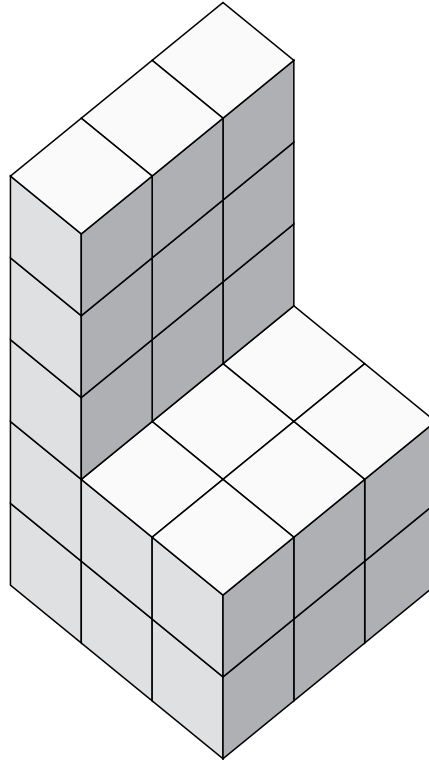

Stuhl



# Eine mögliche Lösung

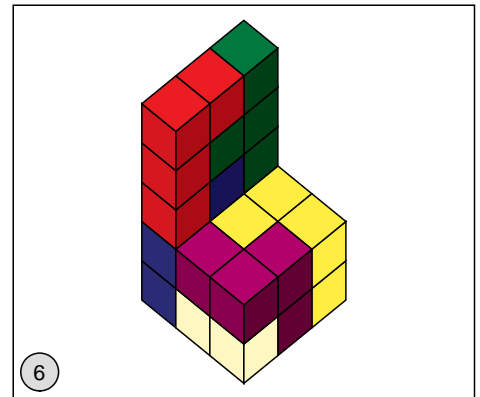
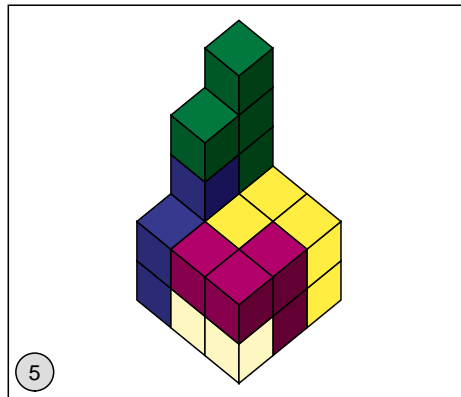
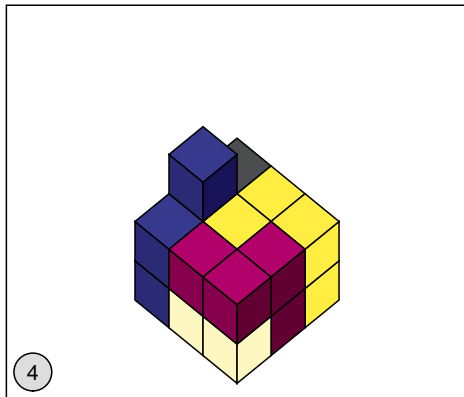
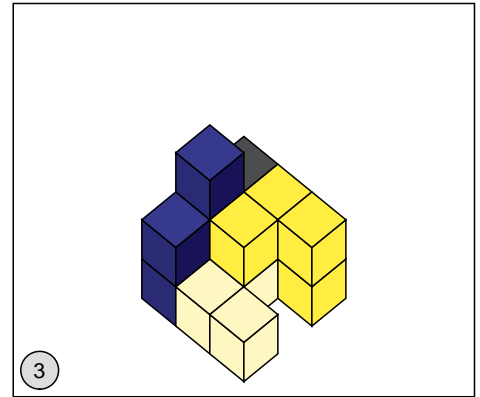
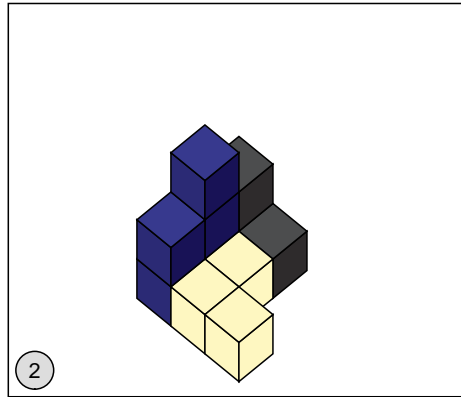
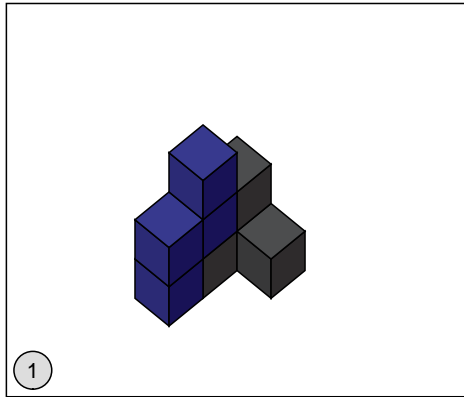

# Somafiguren

23

Aufgabe: Baue den Tunnel aus allen sieben Somateilen.

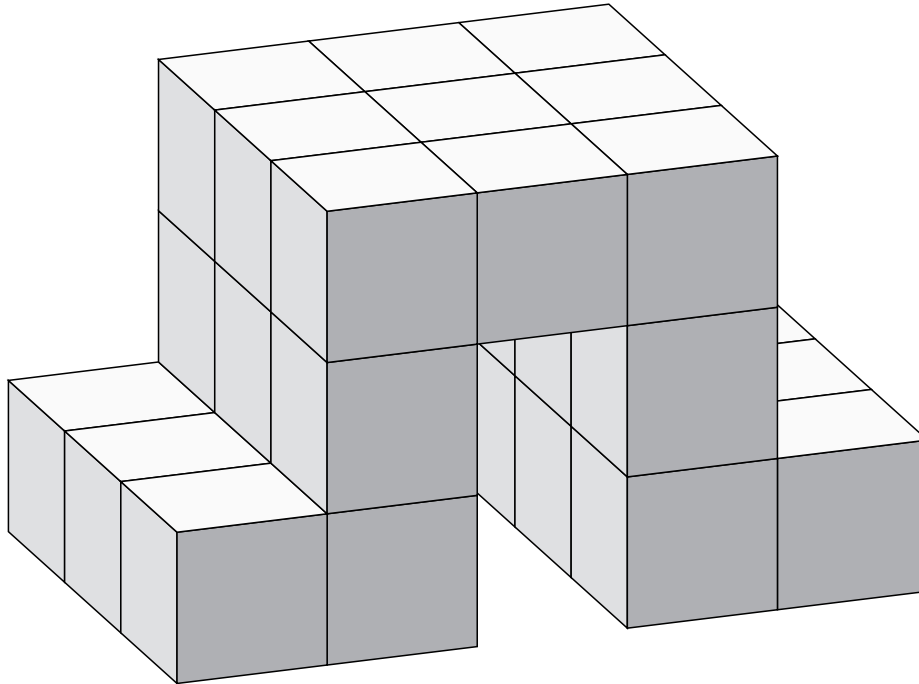

Tunnel



## Eine mögliche Lösung

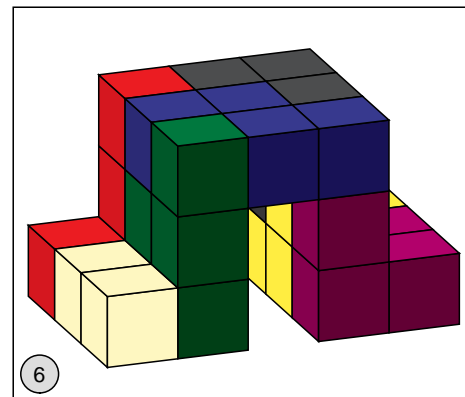
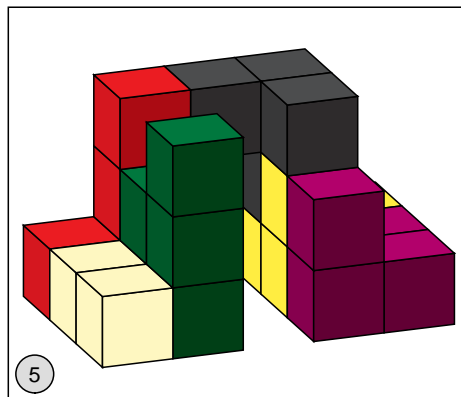
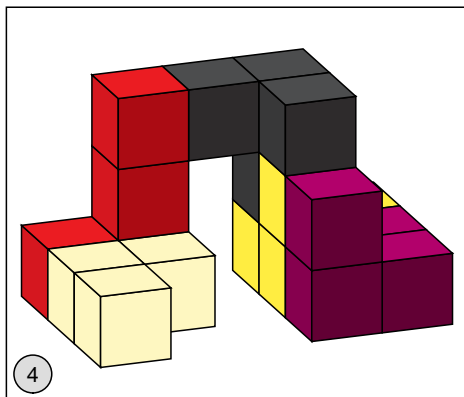
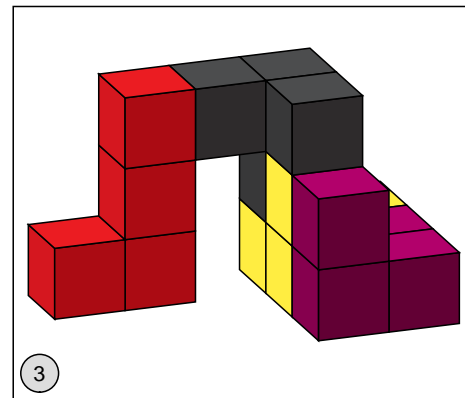
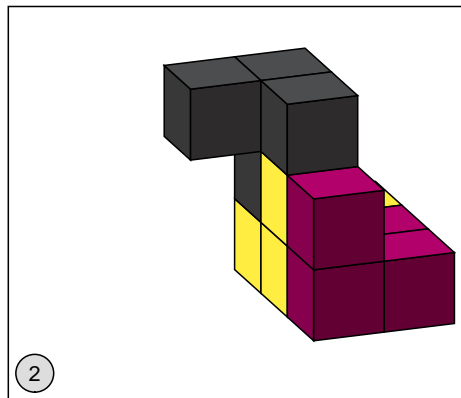
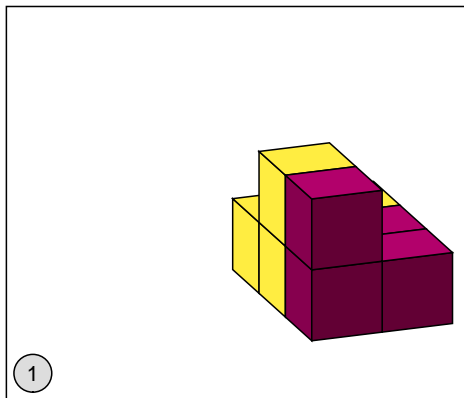

# Somafiguren

24

Aufgabe: Baue das Sofa aus allen sieben Somateilen.

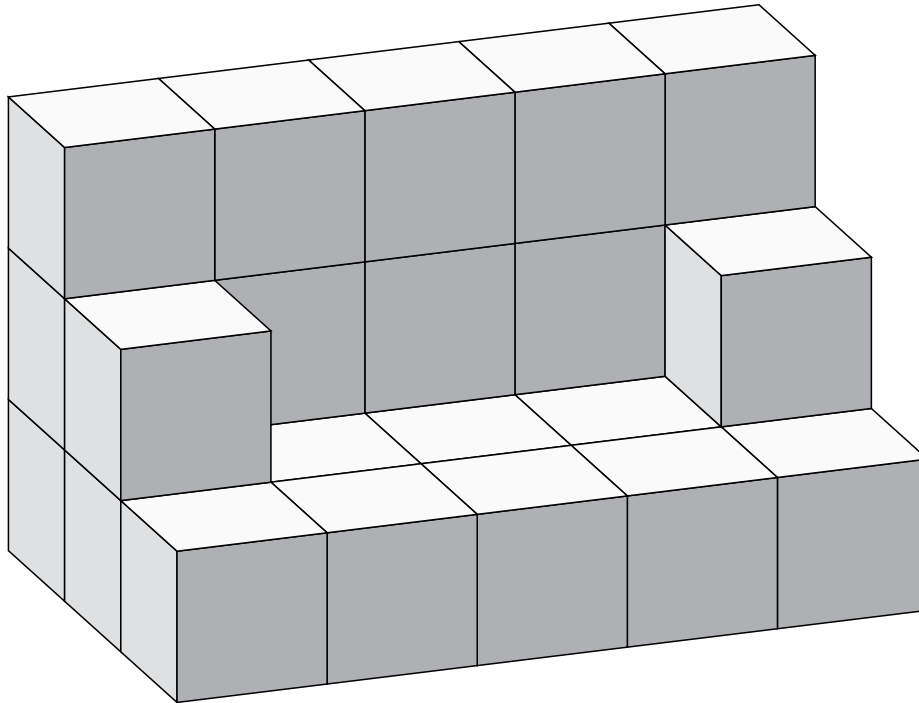

Sofa





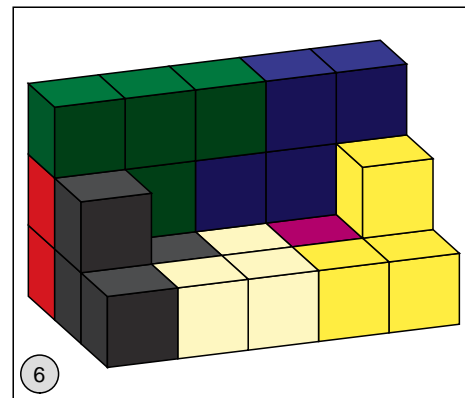
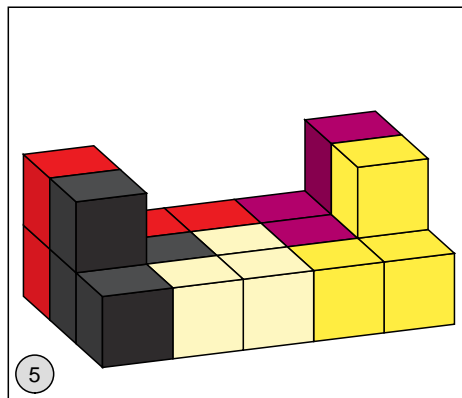
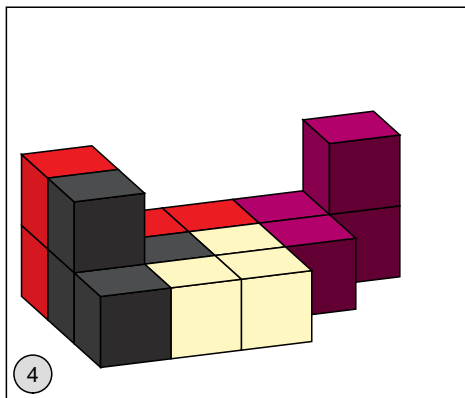
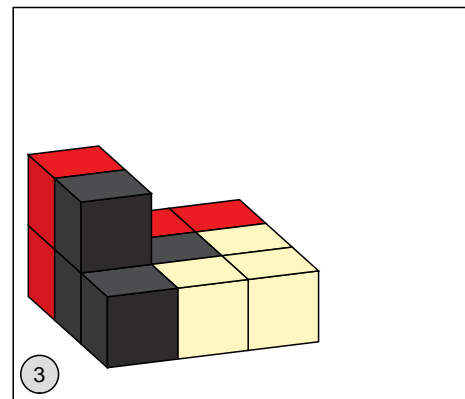
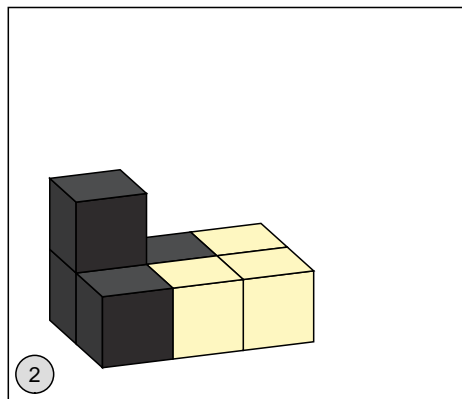
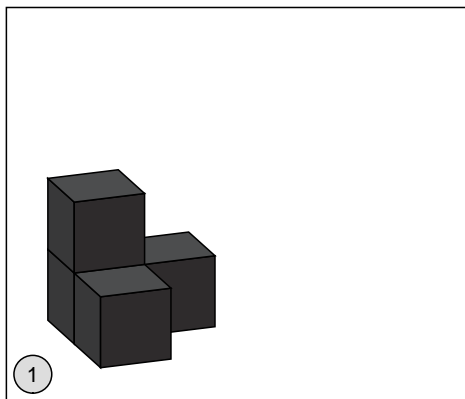

# Somafiguren

25

Aufgabe: Baue den Würfel aus allen sieben Somateilen.

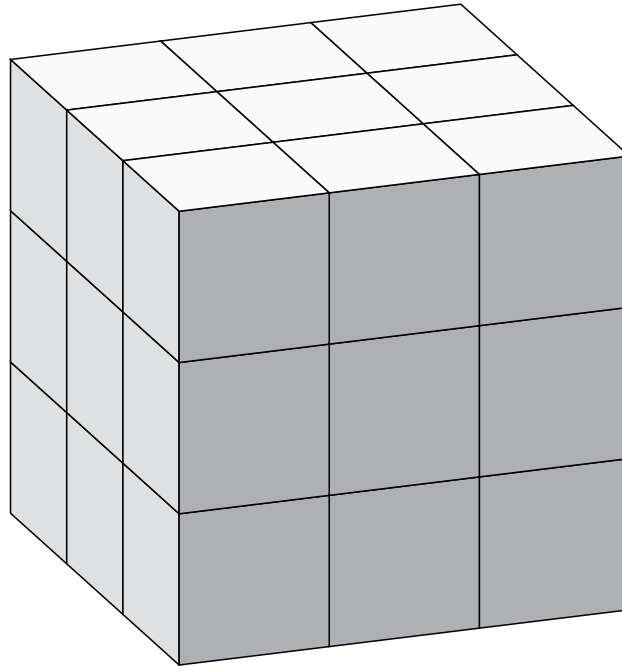

Würfel



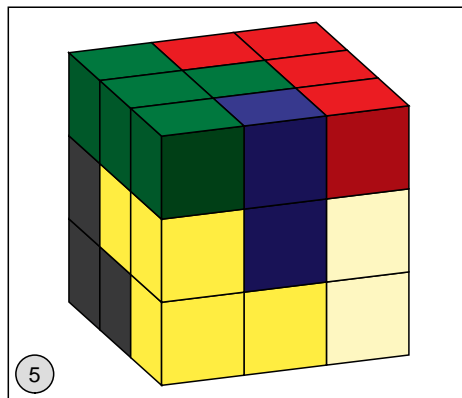
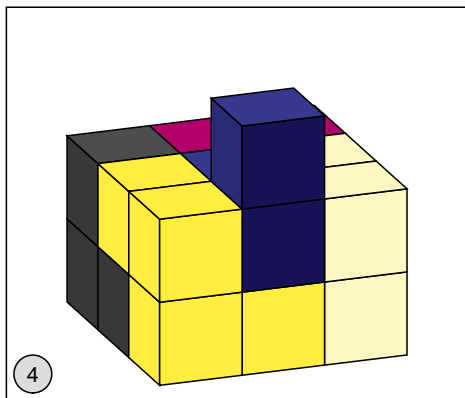
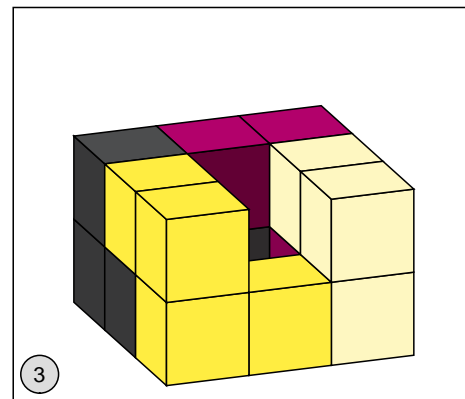
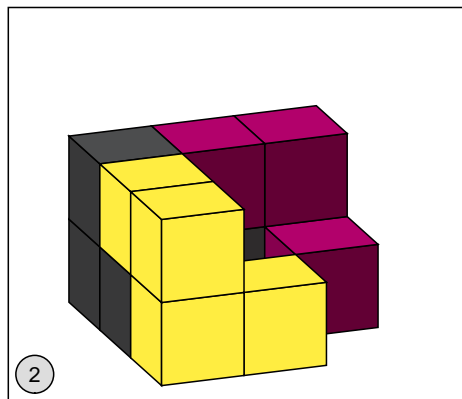
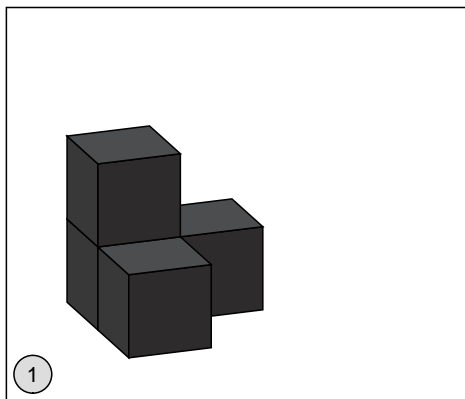

# Somafiguren

26

Aufgabe: Baue die Siegertreppe aus allen sieben Somateilen.

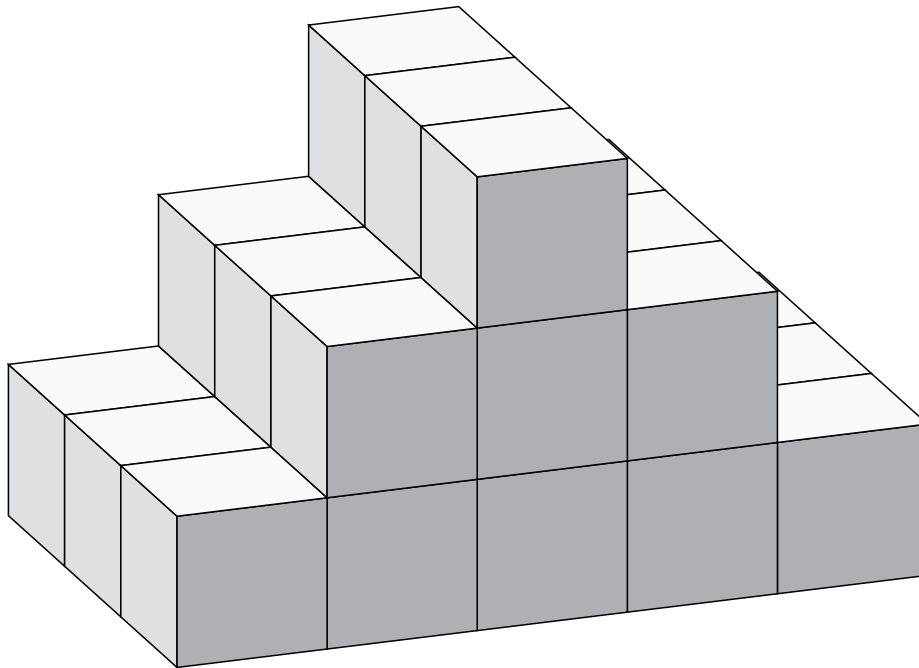

Siegertreppe



# Eine mögliche Lösung

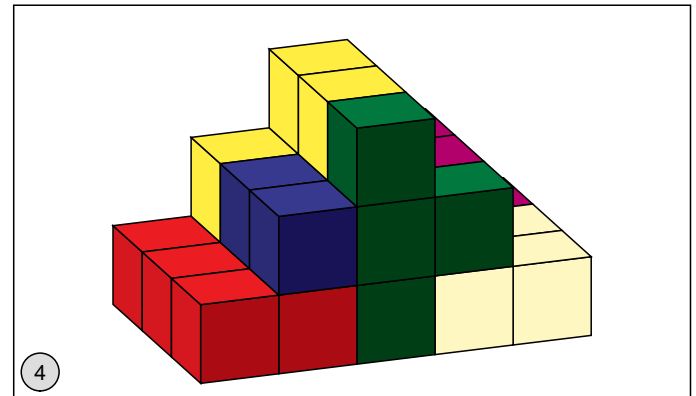
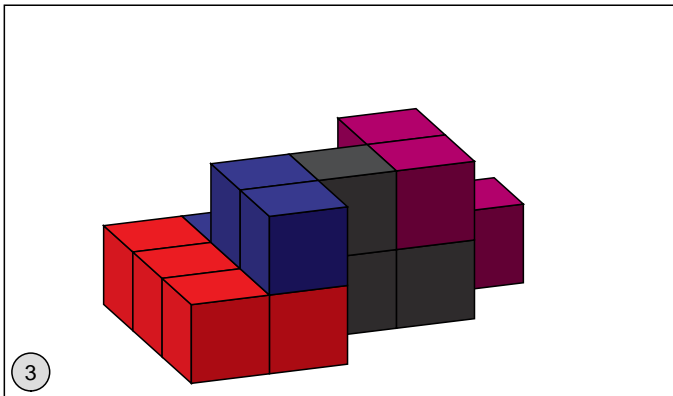
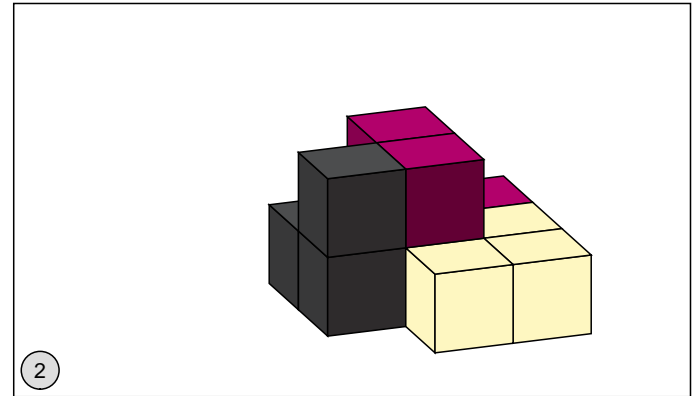
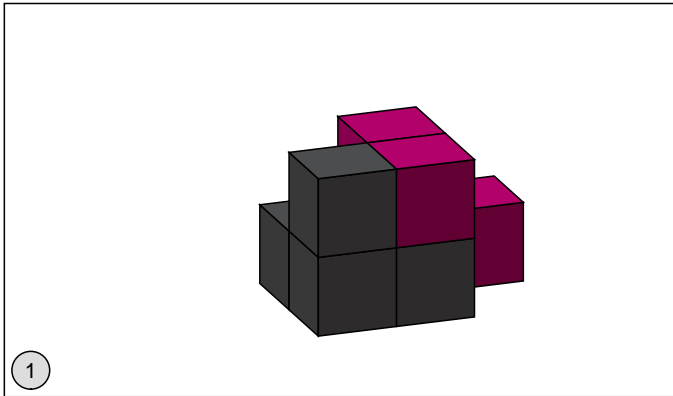

# Somafiguren

27

Aufgabe: Baue die Brücke aus allen sieben Somateilen.

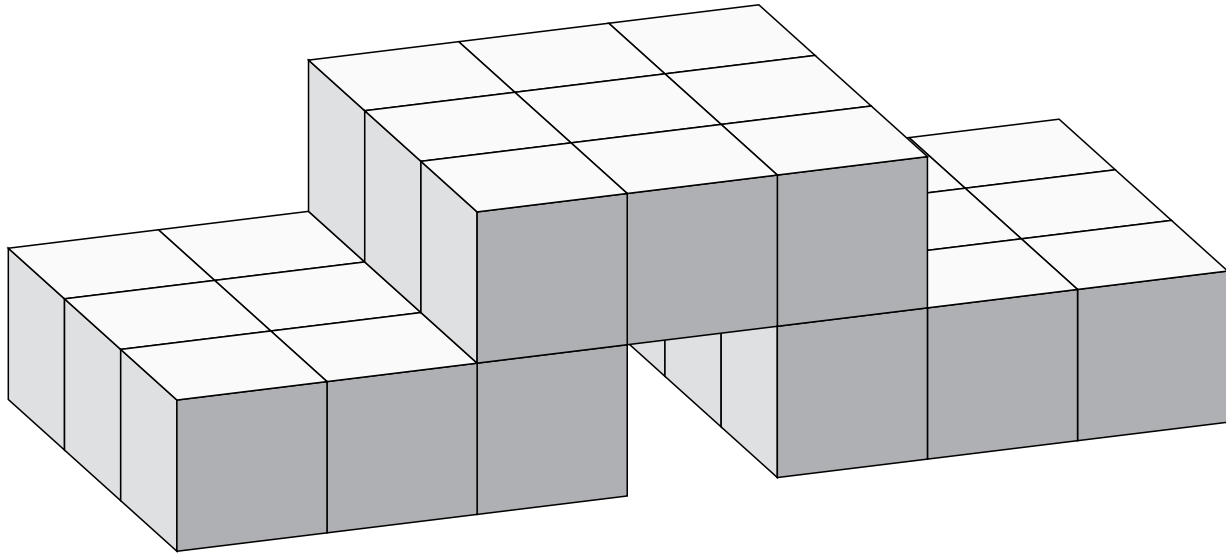

Brücke



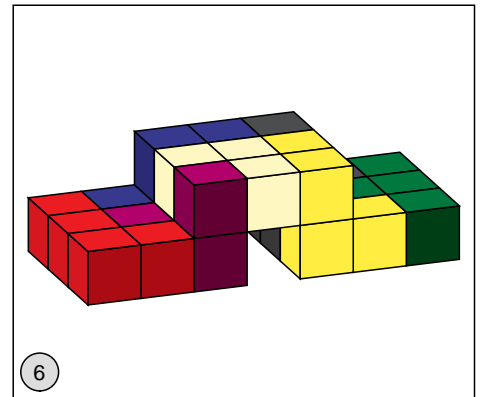
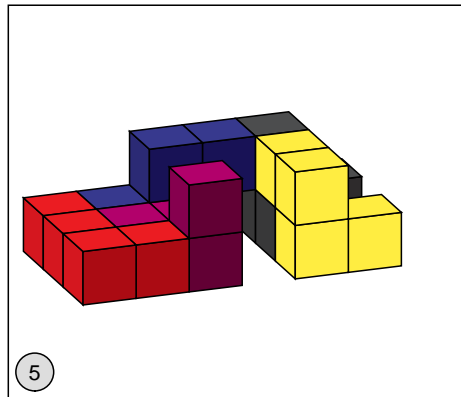
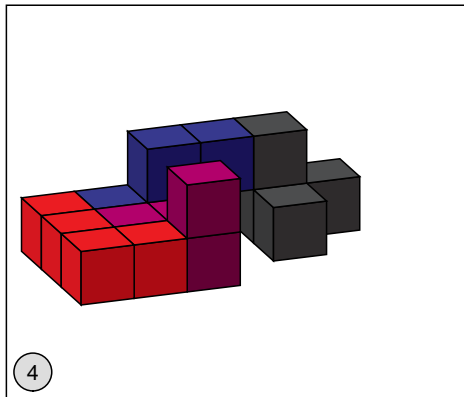
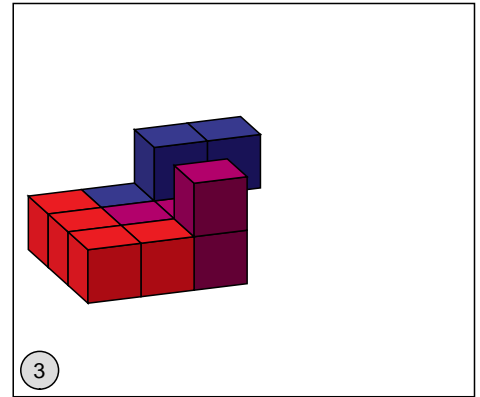
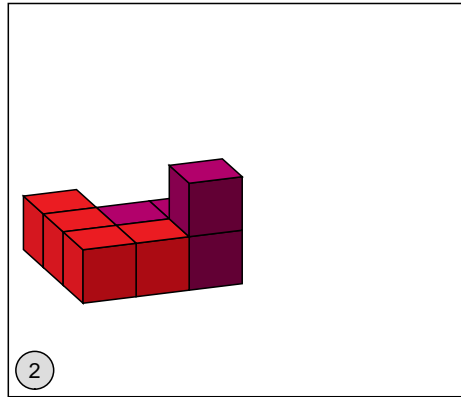
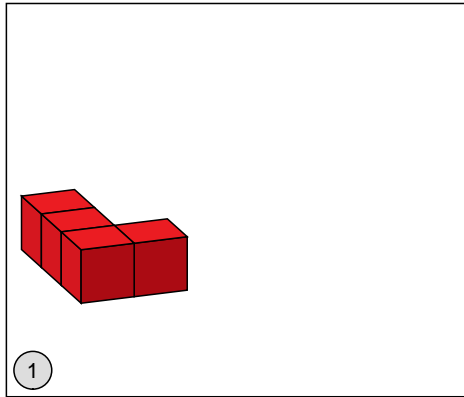

# Somafiguren

28

Aufgabe: Baue den Regenwurm aus allen sieben Somateilen.

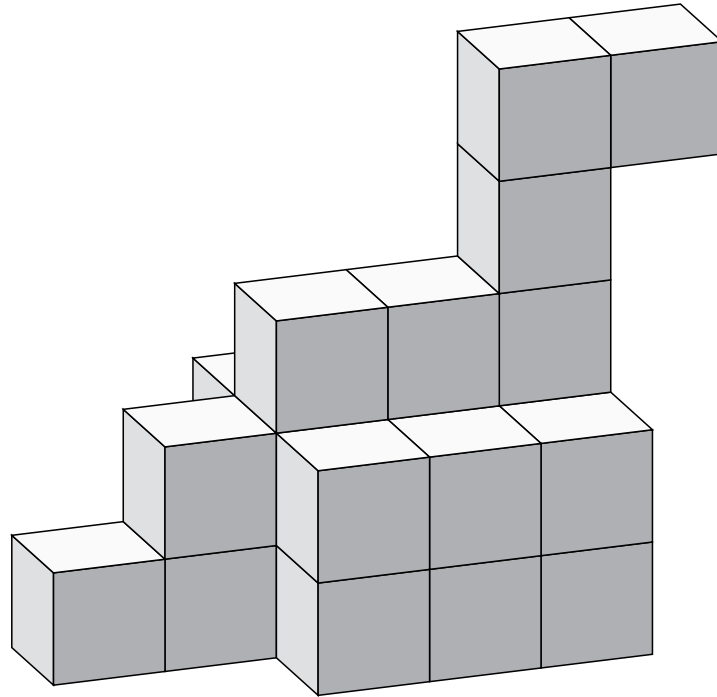

Regenwurm





# Eine mögliche Lösung

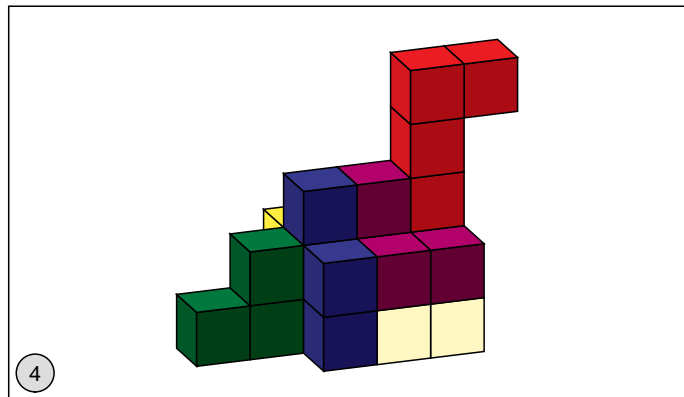
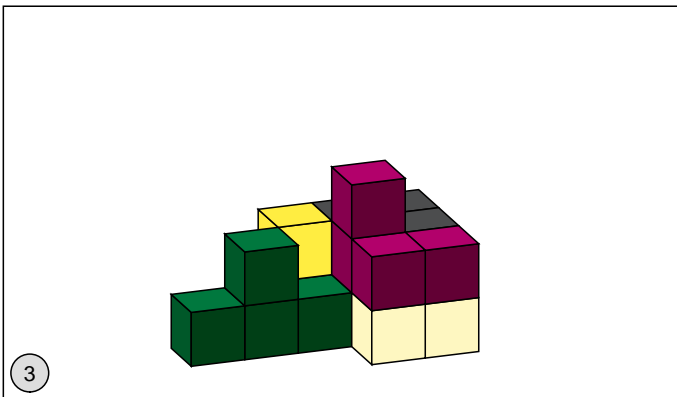
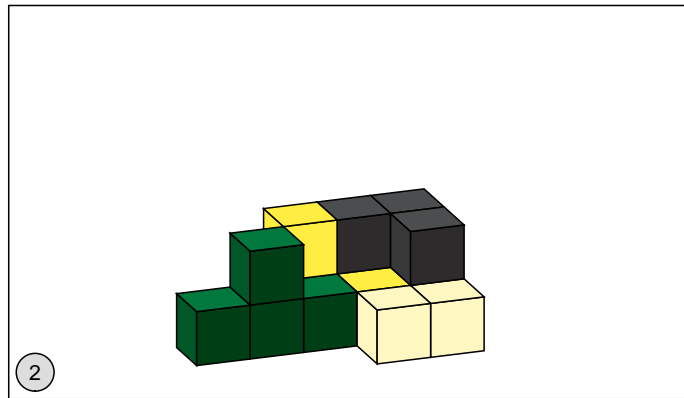
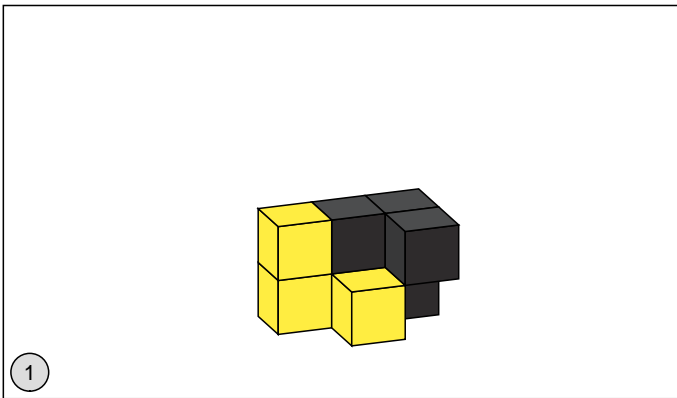

# Somafiguren

29

Aufgabe: Baue das Bett aus allen sieben Somateilen.

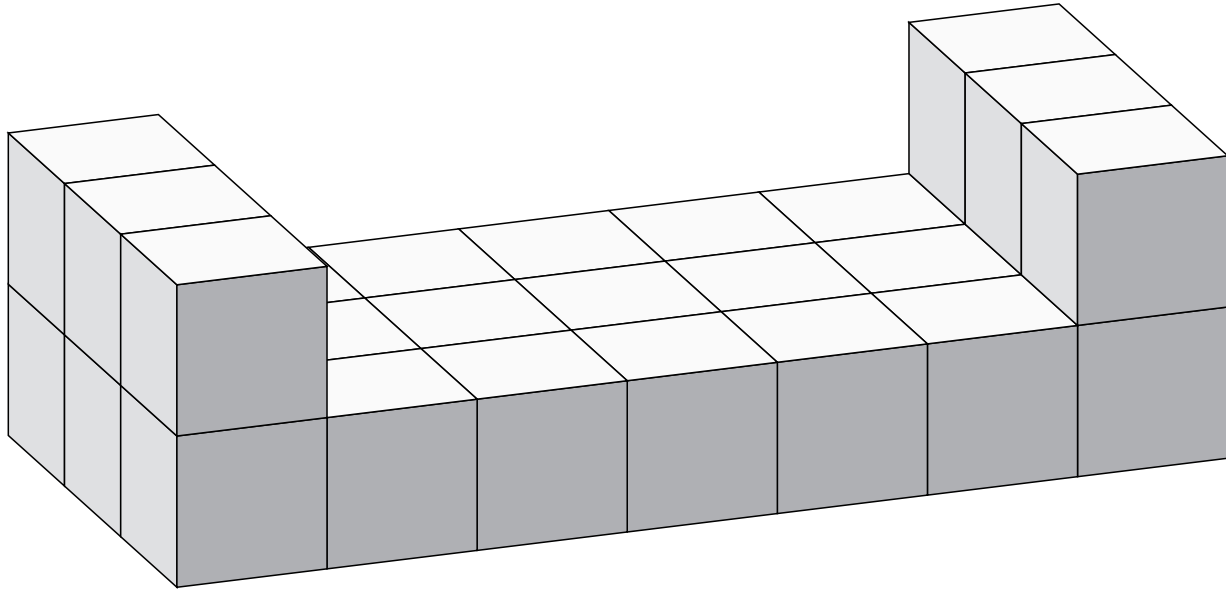

Bett



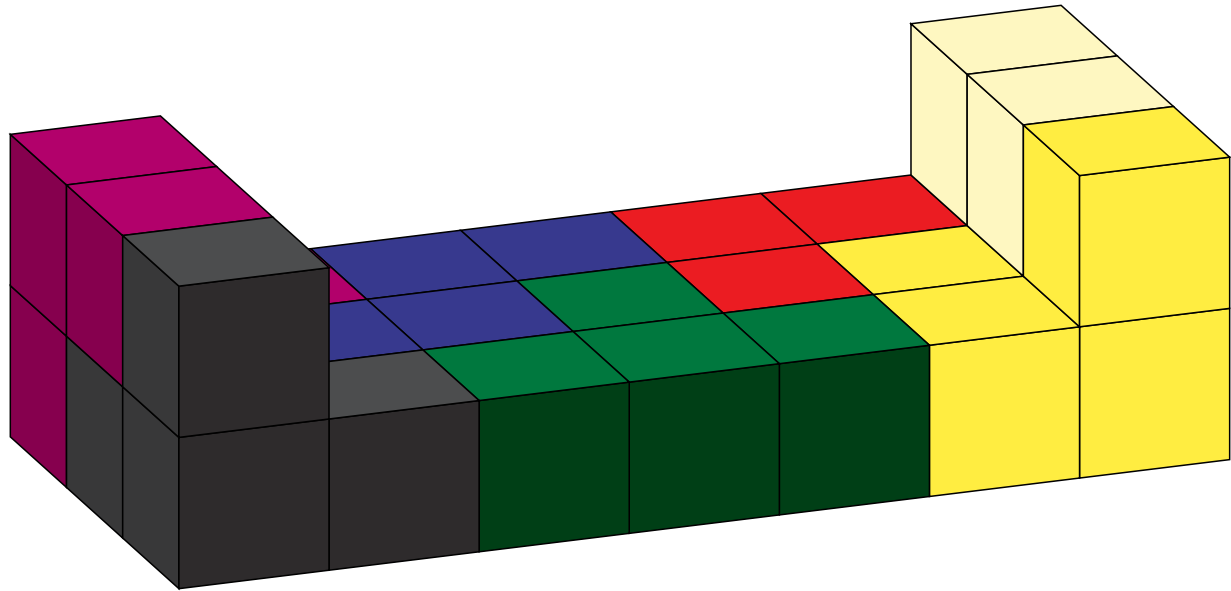

# Somafiguren

30

Aufgabe: Baue den Skorpion aus allen sieben Somateilen.

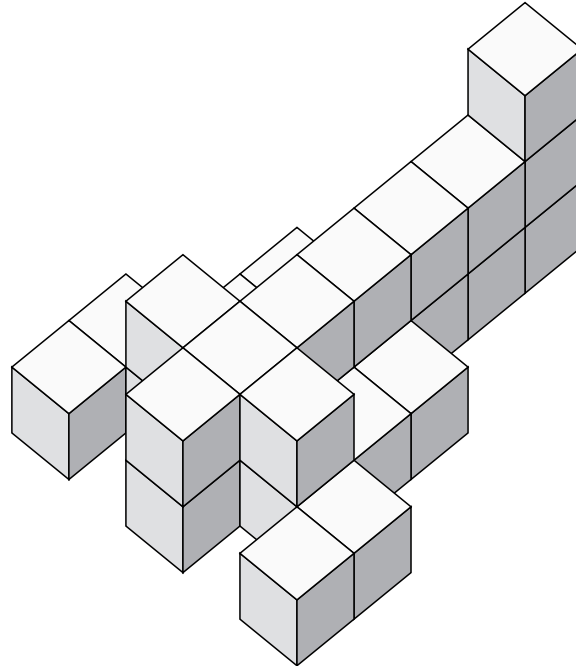

Skorpion





# Somafiguren

31

Aufgabe: Baue den Hund aus allen sieben Somateilen.

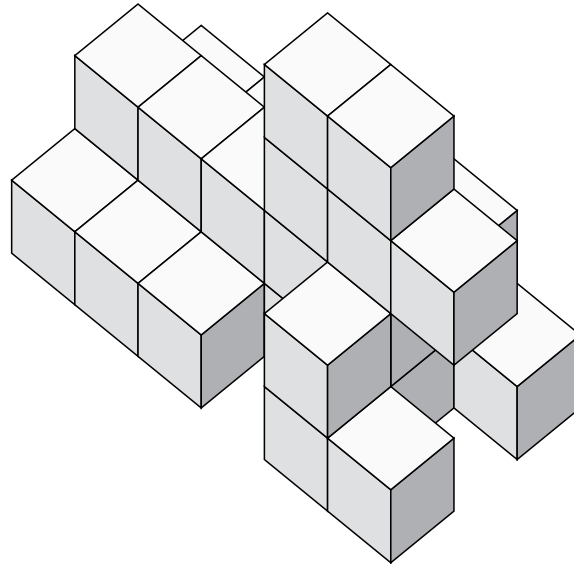

Hund



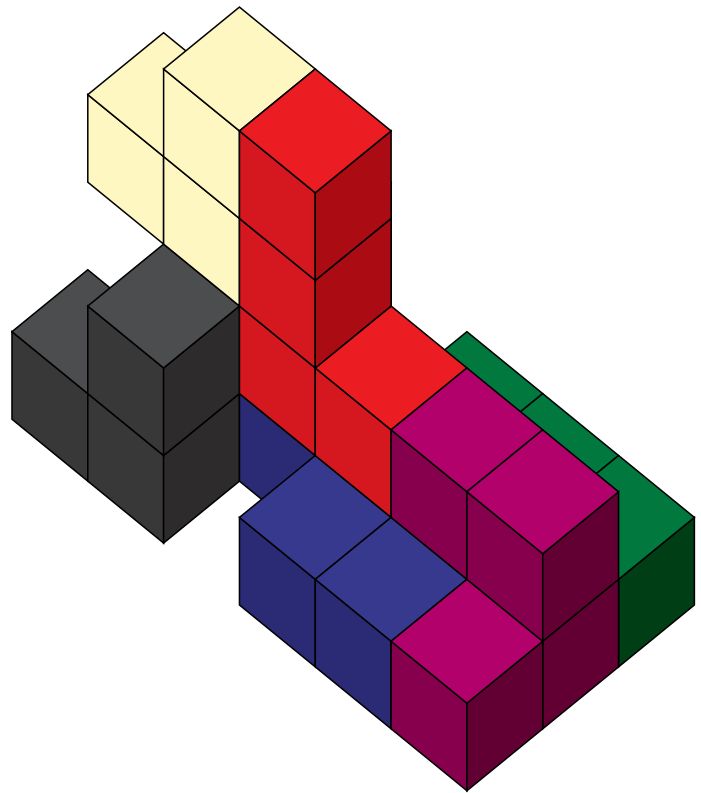
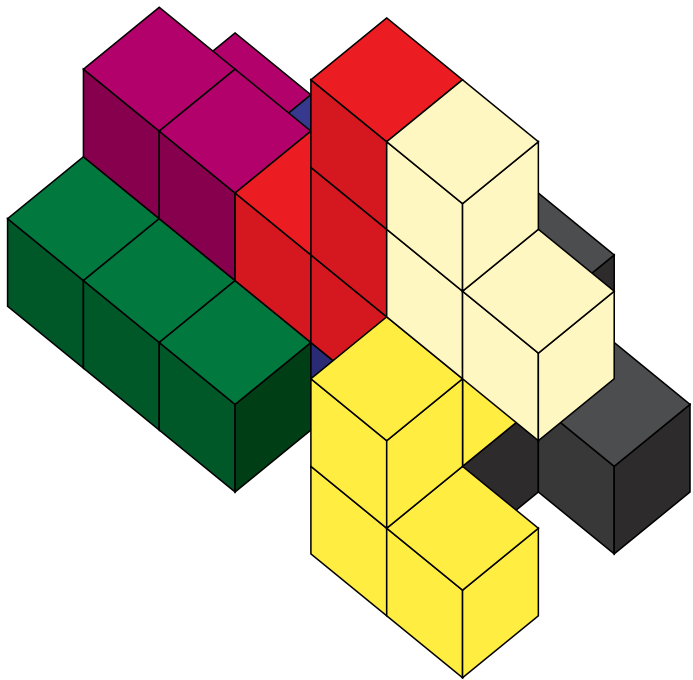

# Somafiguren

32

Aufgabe: Baue die Schlange aus allen sieben Somateilen.

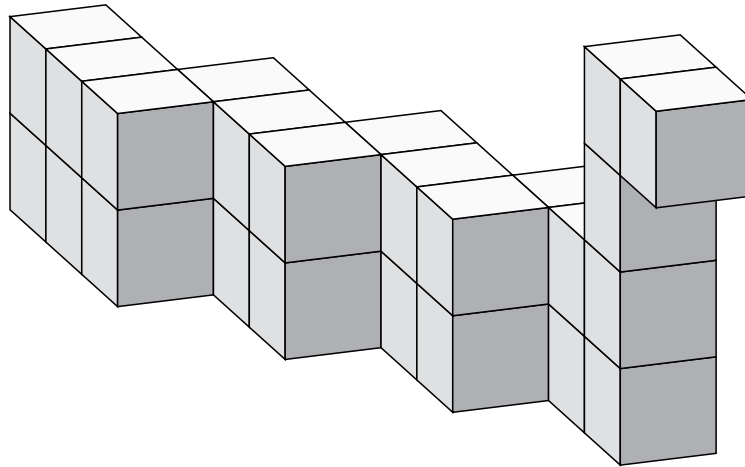

Schlange





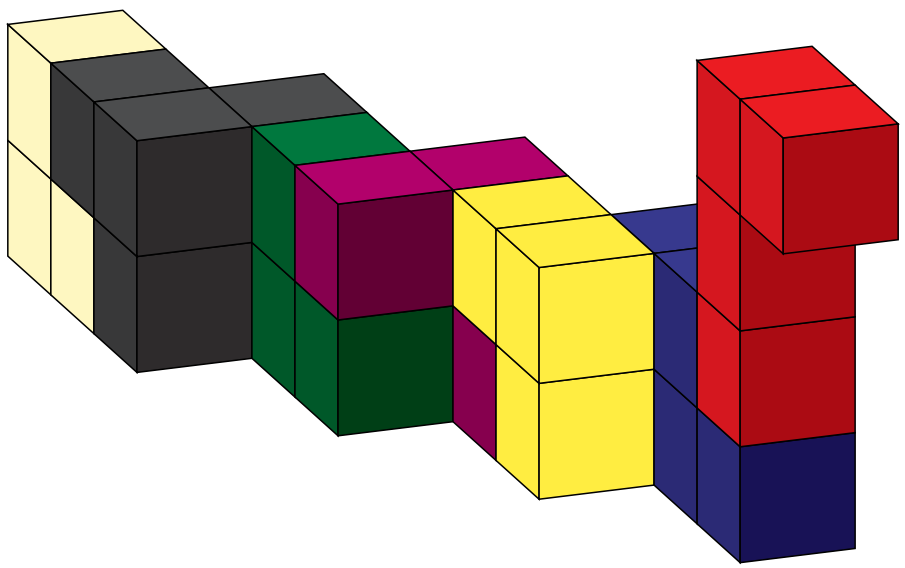

# Somafiguren

33

Aufgabe: Baue das Kamel aus allen sieben Somateilen.

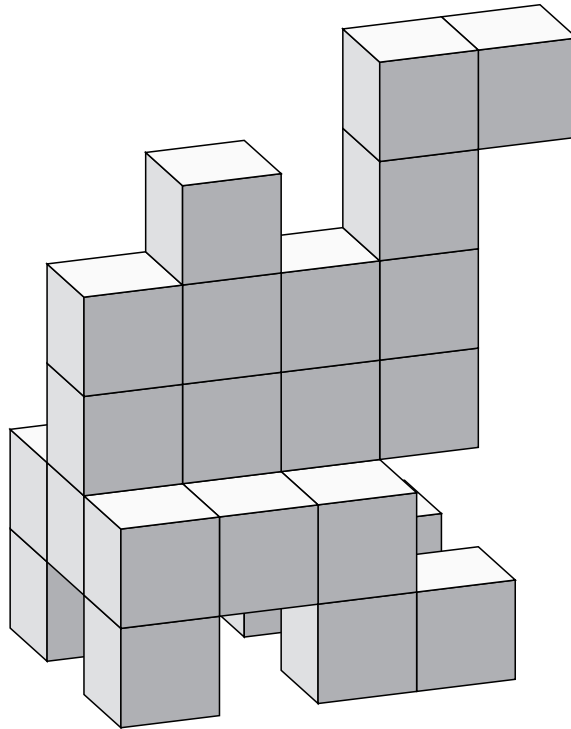

Kamel



# Eine mögliche Lösung

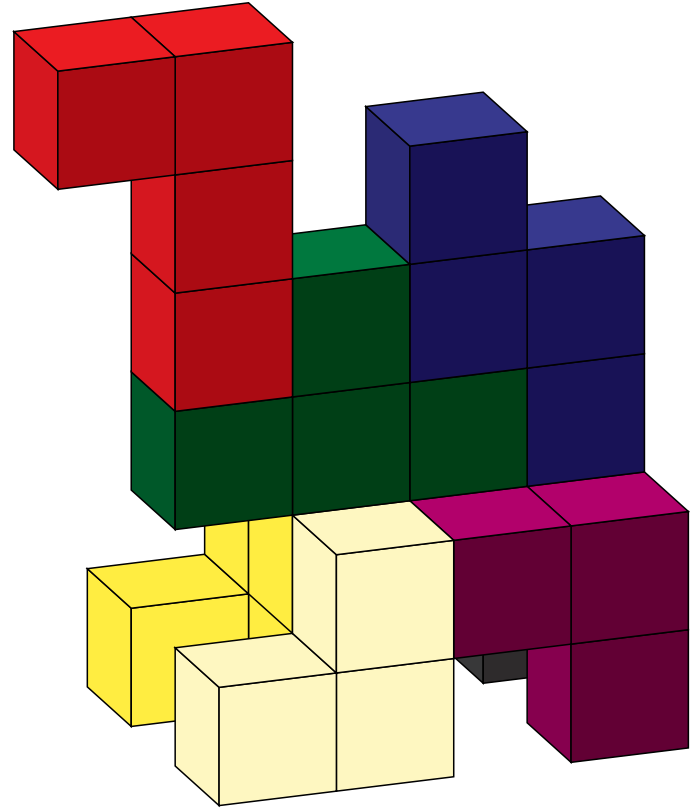
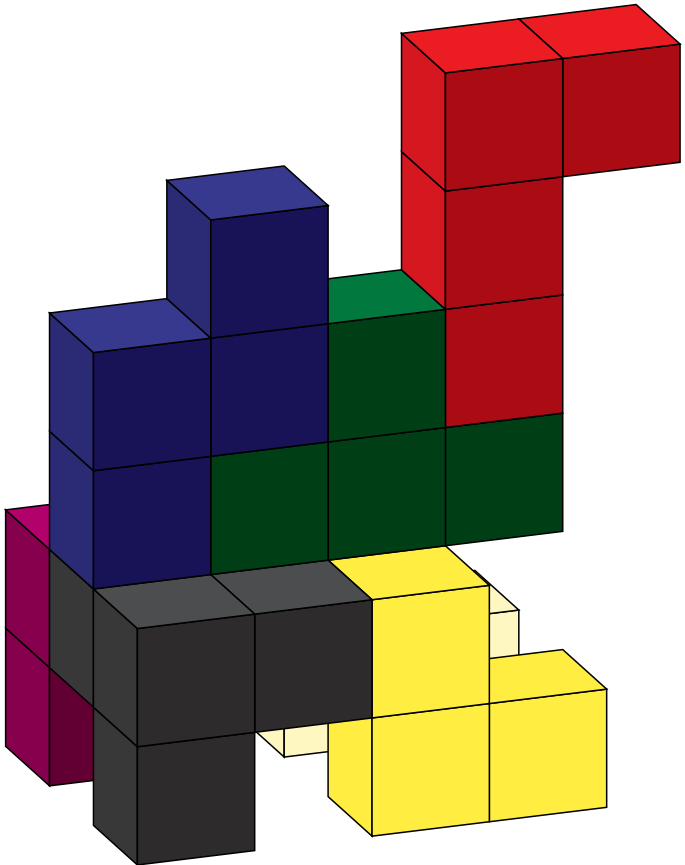

# Somafiguren

34

Aufgabe: Baue die Katze aus allen sieben Somateilen.

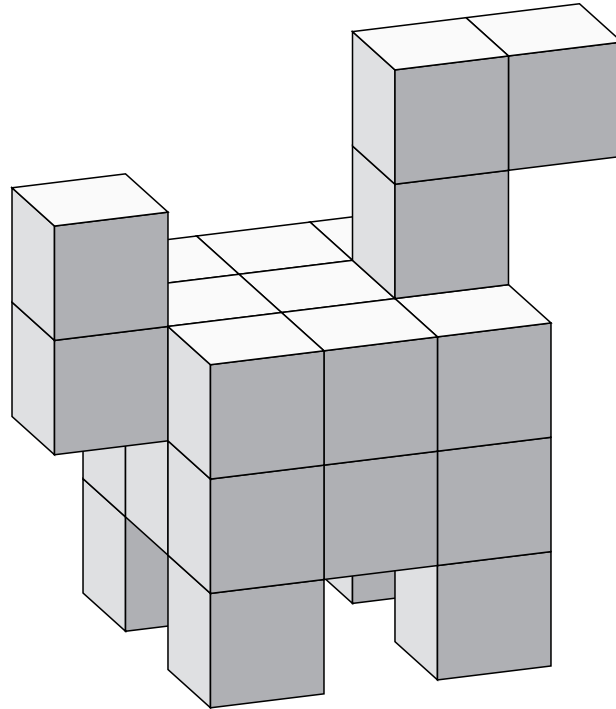

Katze



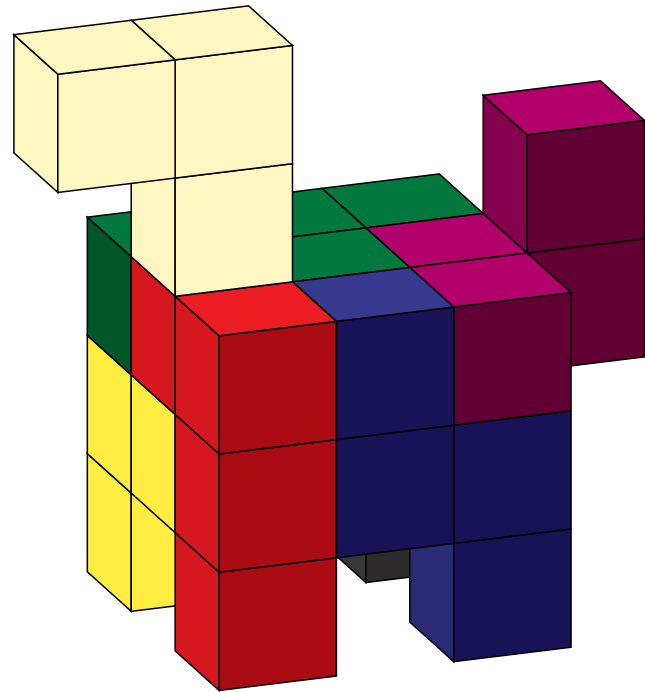
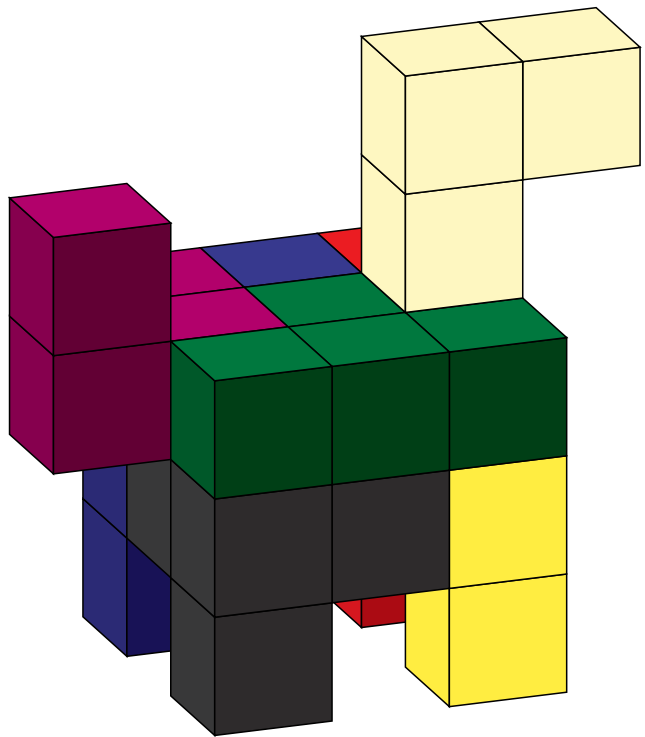

# Somafiguren

35

Aufgabe: Baue den Wetterhahn aus allen sieben Somateilen.

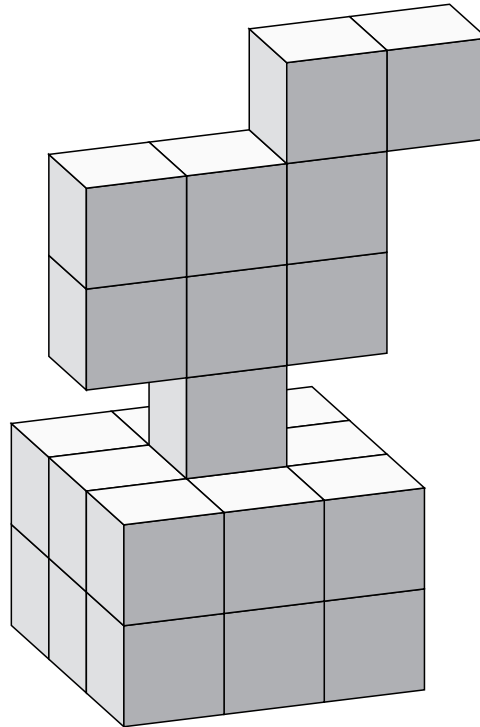

Wetterhahn



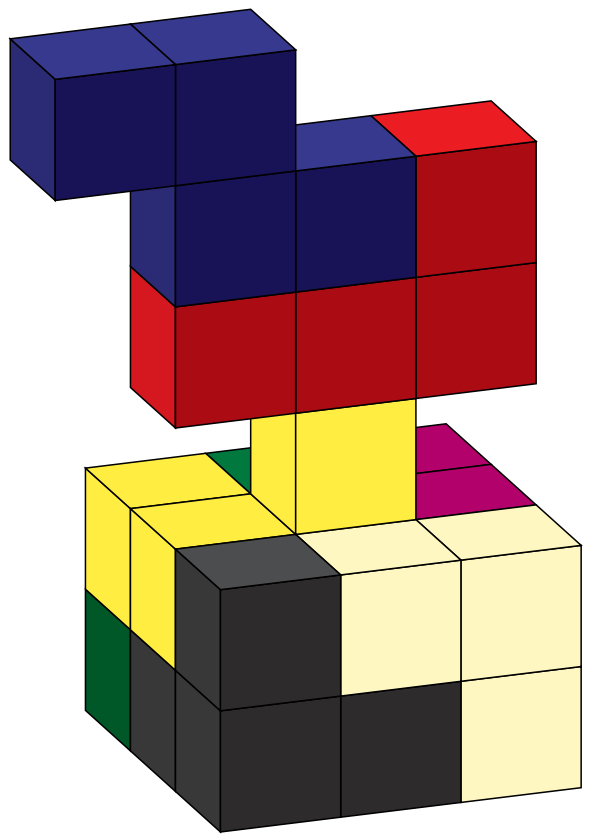
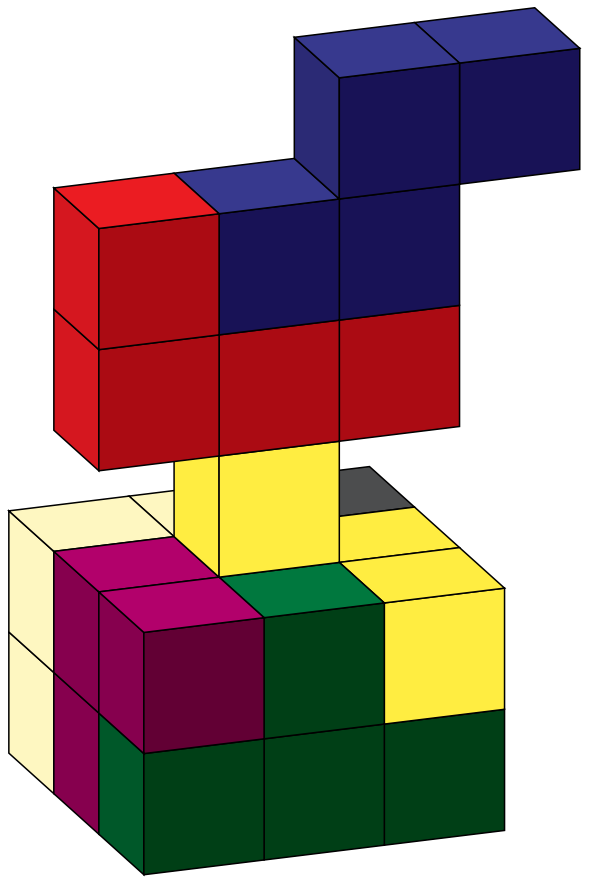

# Somafiguren

36

Aufgabe: Baue die Giraffe aus allen sieben Somateilen.

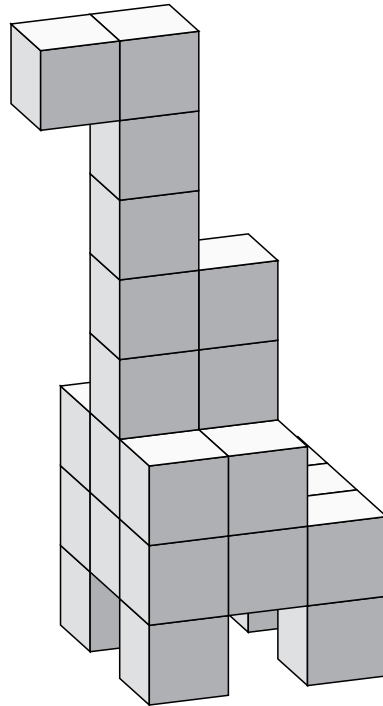

Giraffe





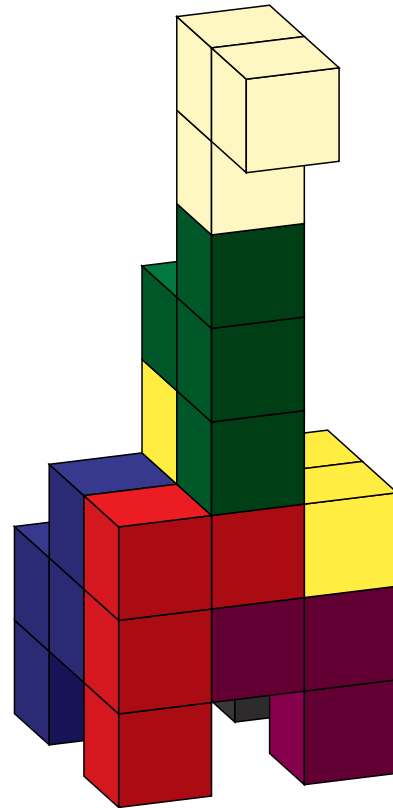
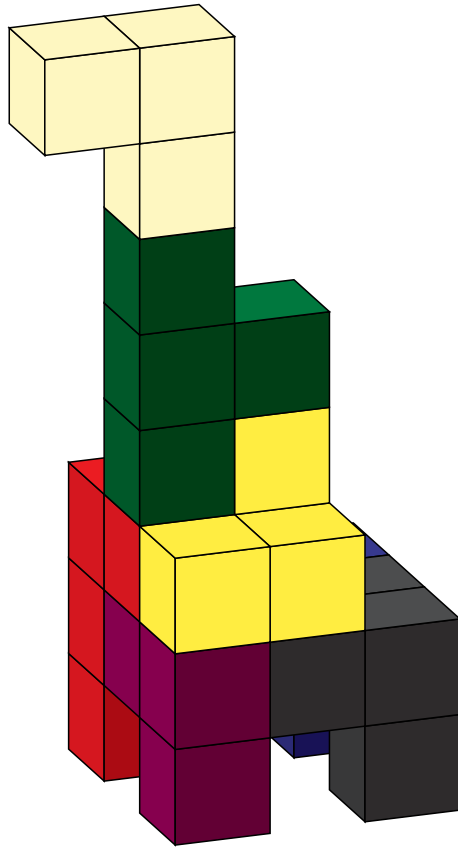

# Somafiguren

37

Aufgabe: Baue die Schildkröte aus allen sieben Somateilen.

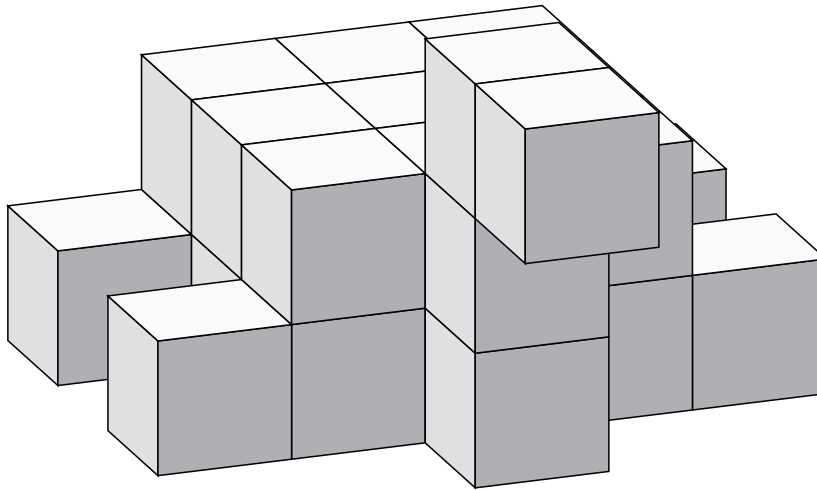

Schildkröte



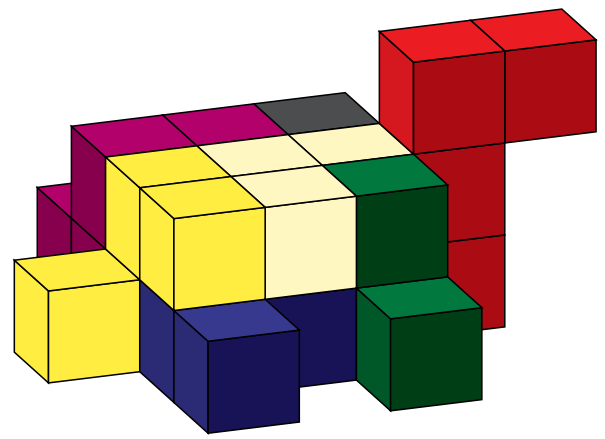
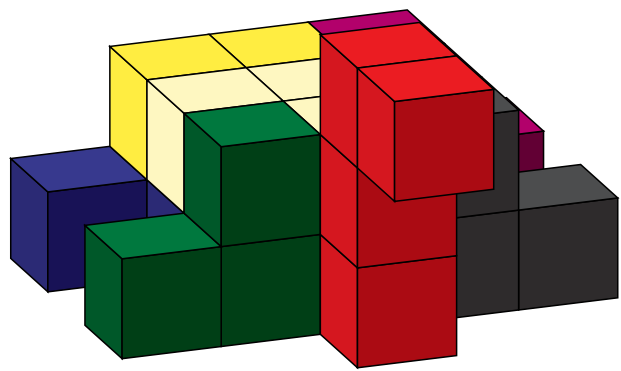

# Somafiguren

38

Aufgabe: Baue die Schaufel aus allen sieben Somateilen.

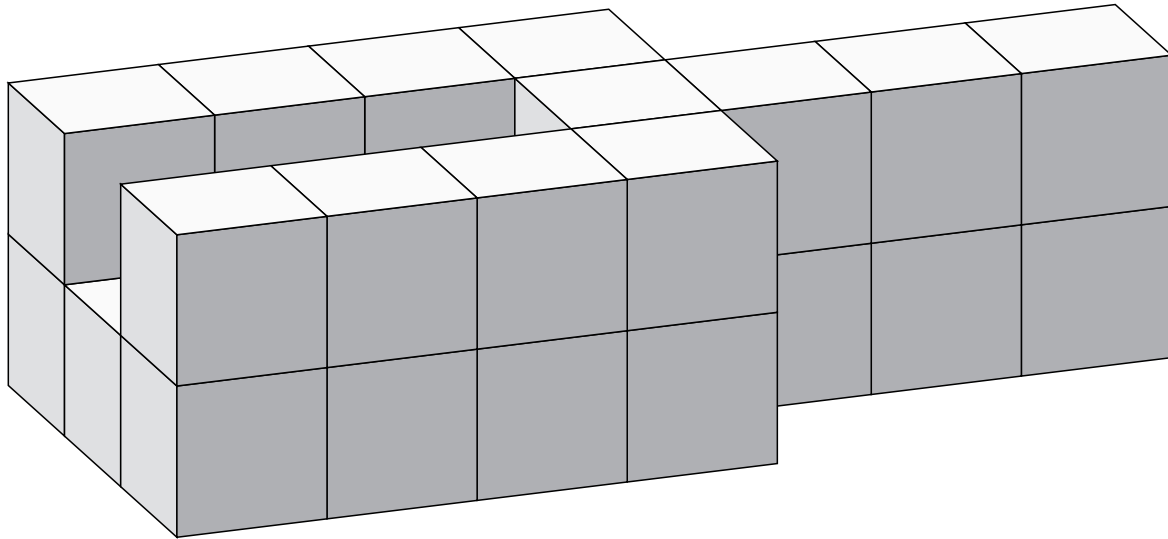

Schaufel



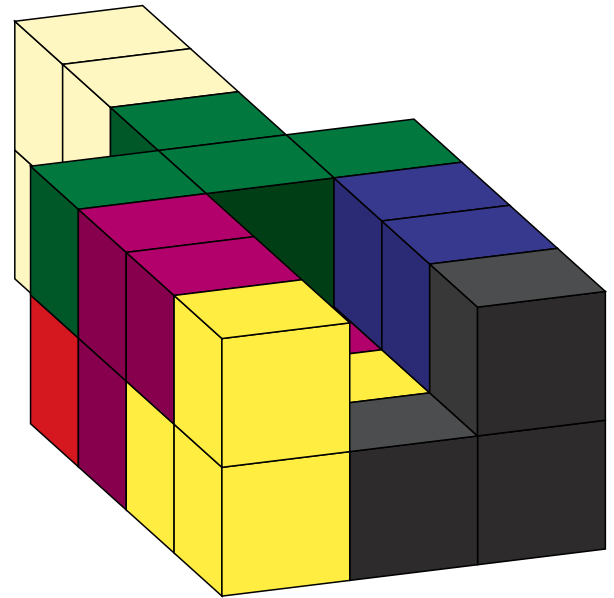
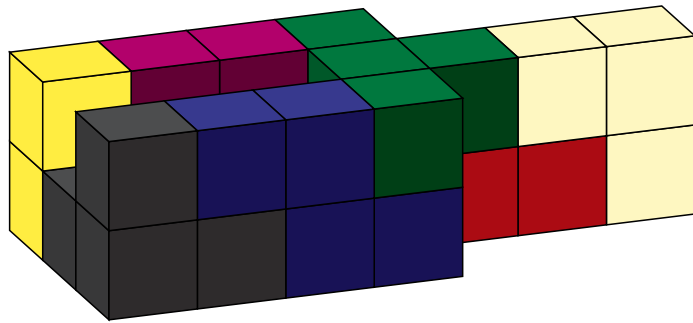

# Somafiguren

39

Aufgabe: Baue die Mauer aus allen sieben Somateilen.

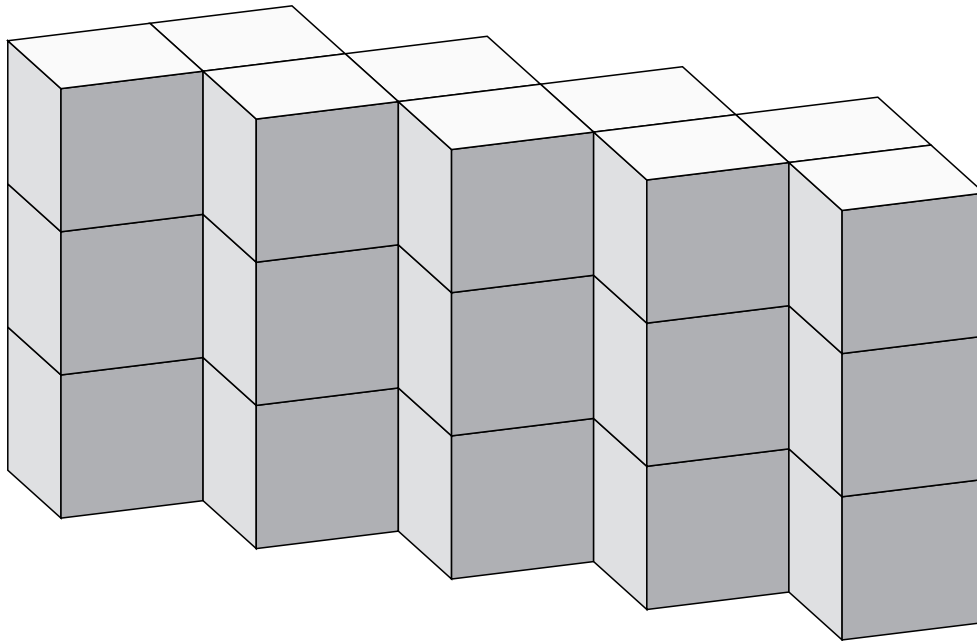

Mauer



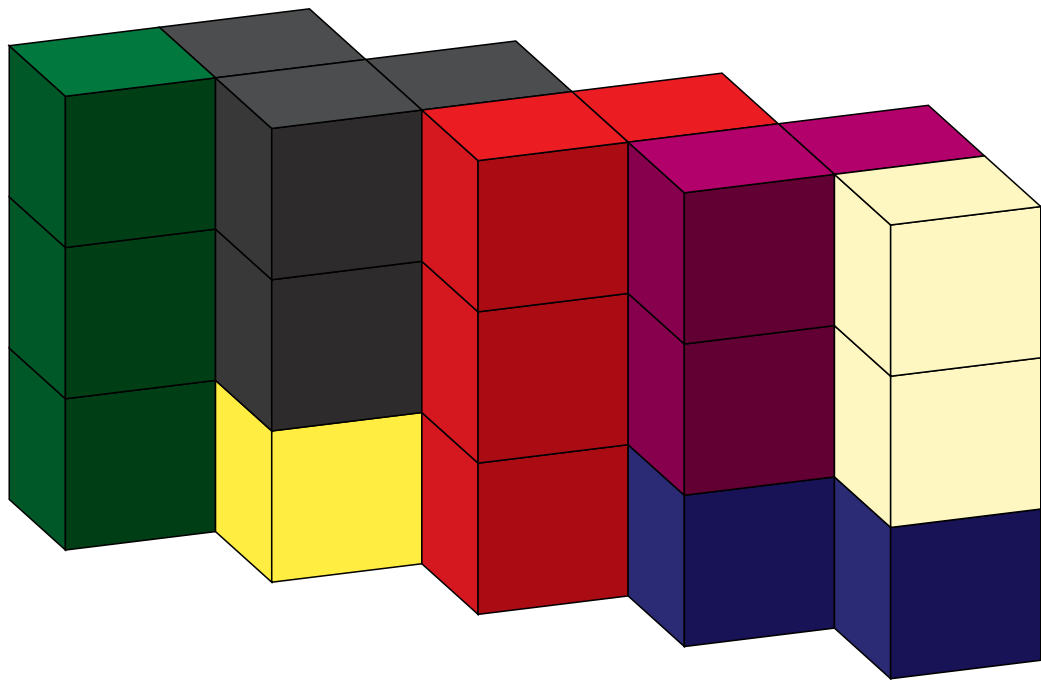

# Somafiguren

40

Aufgabe: Baue den Schlüssel aus allen sieben Somateilen.

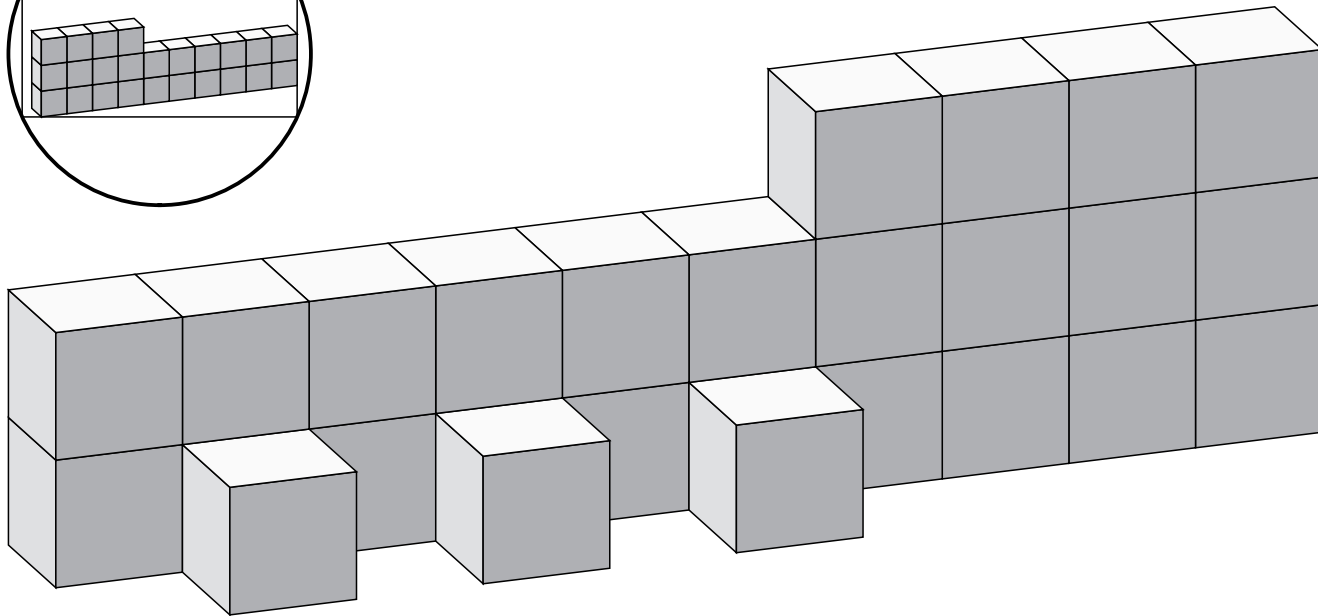
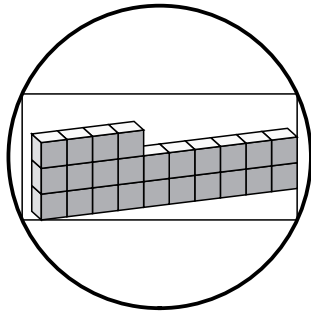

Schlüssel





